



2016-2019
Paragon™
Gold and Silver



SRAM® LLC WARRANTY

EXTENT OF LIMITED WARRANTY

Except as otherwise set forth herein, SRAM warrants its products to be free from defects in materials or workmanship for a period of two years after original purchase. This warranty only applies to the original owner and is not transferable. Claims under this warranty must be made through the retailer where the bicycle or the SRAM component was purchased. Original proof of purchase is required. **Except as described herein, SRAM makes no other warranties, guaranties, or representations of any type (express or implied), and all warranties (including any implied warranties of reasonable care, merchantability, or fitness for a particular purpose) are hereby disclaimed.**

LOCAL LAW

This warranty statement gives the customer specific legal rights. The customer may also have other rights which vary from state to state (USA), from province to province (Canada), and from country to country elsewhere in the world.

To the extent that this warranty statement is inconsistent with the local law, this warranty shall be deemed modified to be consistent with such law, under such local law, certain disclaimers and limitations of this warranty statement may apply to the customer. For example, some states in the United States of America, as well as some governments outside of the United States (including provinces in Canada) may:

Preclude the disclaimers and limitations of this warranty statement from limiting the statutory rights of the consumer (e.g. United Kingdom).

Otherwise restrict the ability of a manufacturer to enforce such disclaimers or limitations.

For Australian customers:

This SRAM limited warranty is provided in Australia by SRAM LLC, 1000 W. Fulton Market, 4th Floor, Chicago, IL, 60607, USA. To make a warranty claim please contact the retailer from whom you purchased this SRAM product. Alternatively, you may make a claim by contacting SRAM Australia, 6 Marco Court, Rowville 3178, Australia. For valid claims SRAM will, at its option, either repair or replace your SRAM product. Any expenses incurred in making the warranty claim are your responsibility. The benefits given by this warranty are additional to other rights and remedies that you may have under laws relating to our products. Our goods come with guarantees that cannot be excluded under the Australian Consumer Law. You are entitled to a replacement or refund for a major failure and for compensation for any other reasonably foreseeable loss or damage. You are also entitled to have the goods repaired or replaced if the goods fail to be of acceptable quality and the failure does not amount to a major failure.

LIMITATIONS OF LIABILITY

To the extent allowed by local law, except for the obligations specifically set forth in this warranty statement, in no event shall SRAM or its third party suppliers be liable for direct, indirect, special, incidental, or consequential damages.

LIMITATIONS OF WARRANTY

This warranty does not apply to products that have been incorrectly installed and/or adjusted according to the respective SRAM user manual. The SRAM user manuals can be found online at sram.com, rockshox.com, avidbike.com, truvativ.com, or zipp.com.

This warranty does not apply to damage to the product caused by a crash, impact, abuse of the product, non-compliance with manufacturers specifications of usage or any other circumstances in which the product has been subjected to forces or loads beyond its design.

This warranty does not apply when the product has been modified, including, but not limited to any attempt to open or repair any electronic and electronic related components, including the motor, controller, battery packs, wiring harnesses, switches, and chargers.

This warranty does not apply when the serial number or production code has been deliberately altered, defaced or removed.

This warranty does not apply to normal wear and tear. Wear and tear parts are subject to damage as a result of normal use, failure to service according to SRAM recommendations and/or riding or installation in conditions or applications other than recommended.

Wear and tear parts are identified as:

Dust seals	Stripped threads/bolts (aluminium, titanium, magnesium or steel)	Handlebar grips	Transmission gears
Bushings	Brake sleeves	Shifter grips	Spokes
Air sealing o-rings	Brake pads	Jockey wheels	Free hubs
Glide rings	Chains	Disc brake rotors	Aero bar pads
Rubber moving parts	Sprockets	Wheel braking surfaces	Corrosion
Foam rings	Cassettes	Bottomout pads	Tools
Rear shock mounting hardware and main seals	Shifter and brake cables (inner and outer)	Bearings	Motors
Upper tubes (stanchions)		Bearing races	Batteries
		Pawls	

Notwithstanding anything else set forth herein, the battery pack and charger warranty does not include damage from power surges, use of improper charger, improper maintenance, or such other misuse.

This warranty shall not cover damages caused by the use of parts of different manufacturers.

This warranty shall not cover damages caused by the use of parts that are not compatible, suitable and/or authorised by SRAM for use with SRAM components.

This warranty shall not cover damages resulting from commercial (rental) use.



SAFETY FIRST!

We care about YOU. Please, always wear your safety glasses and protective gloves when servicing RockShox® products.

Protect yourself! Wear your safety gear!

TABLE OF CONTENTS

ROCKSHOX® SERVICE	5
COMPONENT PREPARATION	5
SERVICE PROCEDURES.....	5
PARTS, TOOLS, AND SUPPLIES.....	6
RECOMMENDED SERVICE INTERVALS.....	7
RECORD YOUR SETTINGS.....	7
TORQUE VALUES.....	7
OIL VOLUME AND LUBRICANT.....	7
PARAGON™ GOLD - EXPLODED VIEW	8
PARAGON SILVER - EXPLODED VIEW	9
LOWER LEG REMOVAL	10
LOWER LEG SERVICE	12
PARAGON GOLD	14
SOLO AIR™ SPRING REMOVAL AND SERVICE.....	14
SOLO AIR SPRING INSTALLATION	17
COMPRESSION DAMPER REMOVAL AND SERVICE	20
REBOUND DAMPER REMOVAL AND SERVICE	23
REBOUND DAMPER INSTALLATION.....	25
COMPRESSION DAMPER INSTALLATION.....	26
PARAGON SILVER	29
COIL SPRING REMOVAL AND SERVICE	29
COIL SPRING INSTALLATION.....	32
COMPRESSION DAMPER REMOVAL AND SERVICE	34
REBOUND DAMPER REMOVAL AND SERVICE	37
REBOUND DAMPER INSTALLATION.....	40
COMPRESSION DAMPER INSTALLATION.....	42
LOWER LEG INSTALLATION	45
PRESSURIZE AND CLEAN	47

RockShox® Service

We recommend that you have your RockShox suspension serviced by a qualified bicycle mechanic. Servicing RockShox suspension requires knowledge of suspension components, as well as the use of specialized tools and lubricants/fluids. Failure to follow the procedures outlined in this service manual may cause damage to your component and void the warranty.

Visit www.sram.com/service for the latest RockShox Spare Parts catalog and technical information. For order information, please contact your local SRAM® distributor or dealer.

Information contained in this publication is subject to change at any time without prior notice.

Your product's appearance may differ from the pictures contained in this publication.



For recycling and environmental compliance information, please visit www.sram.com/company/environment.com.

Component Preparation

Remove the component from the bicycle before service.

Disconnect and remove the remote cable or hydraulic hose from the fork or rear shock, if applicable. For additional information about RockShox remotes, user manuals are available at www.sram.com/service.

Clean the exterior of the product with mild soap and water to avoid contamination of internal sealing part surfaces.

Service Procedures

The following procedures should be performed throughout service, unless otherwise specified.

Clean the part with isopropyl alcohol and a clean, lint-free rag. For hard to reach places (e.g. upper tube, lower leg), wrap a clean, lint-free rag around a non-metallic dowel to clean the inside.

Clean the sealing surface on the part and inspect it for scratches before installing a new o-ring or seal.



Replace o-rings and seals with new ones, as instructed, from the service kit. Use your fingers or a pick to pierce and remove the old seal or o-ring.

Apply grease to new o-rings and seals before installation.

NOTICE

Do not scratch any sealing surface when servicing the product. Scratches can cause leaks. Consult the spare parts catalog to replace any damaged part.



Use aluminum soft jaws when placing a part in a bench vise.

Tighten the part with a torque wrench to the torque value listed in the red bar. When using a crowfoot socket and torque wrench, install the crowfoot socket at 90 degrees to the torque wrench.



Parts

- Paragon™ Service Kit

Safety and Protection Supplies

- Apron
- Clean, lint-free rags
- Nitrile gloves
- Oil pan
- Safety glasses

Lubricants and Fluids

- Isopropyl alcohol
- Liquid-O-Ring® PM600 or SRAM® Butter grease
- RockShox® 5wt Suspension Oil
- RockShox 15wt Suspension Oil

RockShox Tools

- RockShox Bleed Syringe
- RockShox Dust Seal Installation Tool (28 mm/30 mm)
- RockShox Top Cap/Cassette Tool (3/8" / 24 mm)

Bicycle Tools

- Bicycle work stand
- Downhill tire lever
- Shock pump

Common Tools

- 2, 2.5, 5 mm hex bit sockets
- 2, 2.5, 5 mm hex wrenches
- Flat blade screwdriver
- Heat gun
- Internal retaining ring pliers - large
- Long plastic or wooden dowel (≤10 mm diameter)
- Long plastic or wooden dowel (15 mm - 18 mm diameter)
- Pick
- Plastic mallet
- Scissors or sharp blade
- Socket wrench
- Torque wrench

SAFETY INSTRUCTIONS

Always wear safety glasses and nitrile gloves when working with suspension oil.

Place an oil pan on the floor underneath the area where you will be working on the fork.

Recommended Service Intervals

Regular service is required to keep your RockShox® product working at peak performance. Follow this maintenance schedule and install the service parts included in each service kit that corresponds with the Service Hours Interval recommendation below. For spare part kit contents and details, refer to the RockShox Spare Parts Catalog at www.sram.com/service.

Service Hours Interval	Maintenance	Benefit
Every ride	Clean dirt from upper tubes and wiper seals	Extends wiper seal lifespan
		Minimizes damage to upper tubes
		Minimizes lower leg contamination
Every 50 Hours	Perform lower leg service	Restores small bump sensitivity
		Reduces friction
		Extends bushing lifespan
Every 200 Hours	Perform damper and spring service	Extends suspension lifespan
		Restores small bump sensitivity
		Restores damping performance

Record Your Settings

Use the charts below to record your suspension settings to return your suspension to its pre-service settings. Record your service date to track service intervals.

Service Hours Interval	Date of Service	Air Pressure
50		
100		
150		
200		
400		

Torque Values

Part	Tool	Torque
Bottom Bolts	5 mm hex	6.8 N•m (60 in-lb)
Top Caps	RockShox Top Cap / Cassette Lockring Tool	12.4 N•m (110 in-lb)

Oil Volume and Lubricant

Model Year	Fork	Model	Damper						Spring					
			Damper	Upper Tube			Lower Leg			Spring	Upper Tube		Lower Leg	
				Oil Weight	Oil Height* (mm)	Volume (mL)	Oil Weight	Volume (mL)	Oil Weight		Volume (mL)	Oil Weight	Volume (mL)	
2016	Paragon™ Gold	TK	TurnKey™	5wt	80-85	87	15wt	12	Solo Air™	5wt	3-6	15wt	12	
	Paragon Silver					100			Coil	Grease Coil Spring				
2017 - 2019	Paragon Gold	RL	Motion Control™	5wt	80-85	87	15wt	12	Solo Air	5wt	3-6	15wt	12	
	Paragon Silver	TK	TurnKey			100			Coil	Grease Coil Spring				

*Oil Height - Measure from the top of the crown (above the upper tube) down to the oil.

Paragon™ Gold - Exploded View

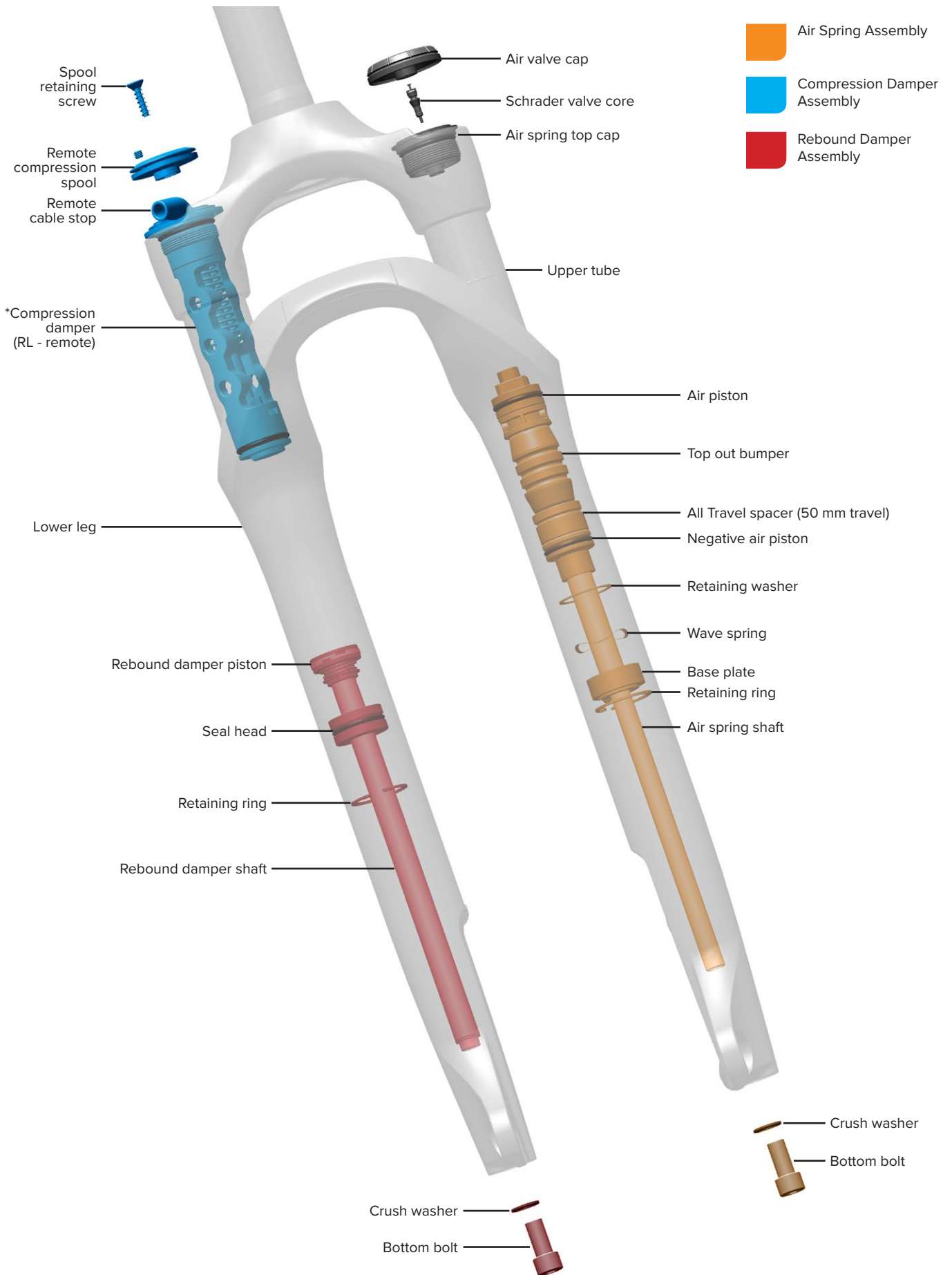

*Paragon Gold RL and TK compression dampers are available in crown or remote adjust.

Paragon™ Silver - Exploded View

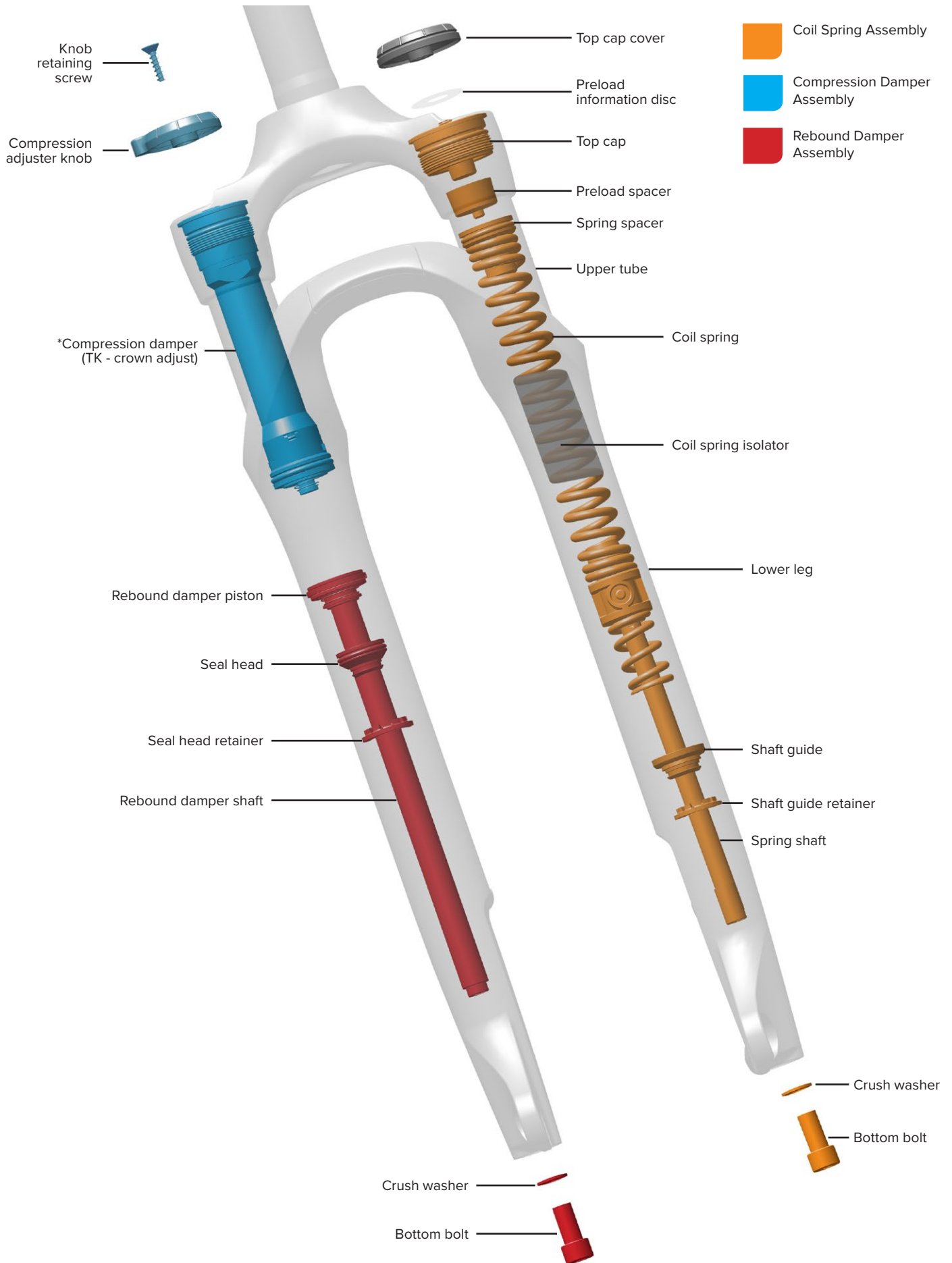

*Paragon Silver TK compression dampers are available in crown or remote adjust.

Lower Leg Removal

- 1 Clamp the steerer tube into the bicycle work stand.

Paragon™ Silver: Skip to step 4.



- 2 **Paragon Gold:** Unthread and remove the air valve cap.



- 3 **Paragon Gold:** Depress the Schrader valve and release all air pressure.

⚠ CAUTION - EYE HAZARD

Verify all pressure is removed from the fork before proceeding. Failure to do so can result in injury and/or damage to the fork. Wear safety glasses.



- 4 Place an oil pan beneath the fork to catch the draining oil. Loosen both bottom bolts 3 to 4 turns.

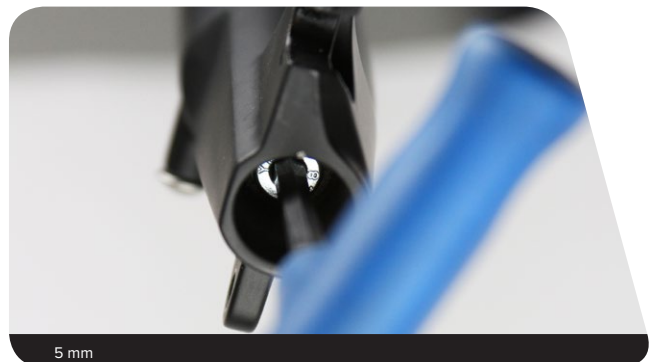

- 5** Insert a 5 mm hex wrench into each bottom bolt and strike the wrench with a plastic mallet to dislodge each shaft from the lower leg.
Remove each bottom bolt.



- 6** Firmly pull the lower leg downward until oil begins to drain. Continue pulling downward to remove the lower leg.
If the lower leg does not slide off of the upper tubes, or if oil does not drain from either side, the press fit of the shafts into the lower leg may still be engaged.
Reinstall the bottom bolts 2 to 3 turns and repeat the previous step.

NOTICE

Do not strike the fork arch with any tool when removing the lower leg as this could damage the lower leg.



Lower Leg Service

- 1 Stabilize the lower leg on a bench top or on the floor. Place the tip of a downhill tire lever under the dust wiper seal. Press down on the downhill tire lever handle to remove the seal. Repeat on the other side.
Discard the dust wiper seals after they are removed.

NOTICE

Keep the lower leg stable. Do not allow the lower leg to twist in opposite directions, compress toward each other, or be pulled apart. This will damage the lower leg.



- 2 Remove and discard the foam rings.



- 3 Spray isopropyl alcohol on the inside and outside of the lower leg. Clean the outside of the lower leg with a rag. Wrap a rag around a long dowel, insert it into each lower leg and clean the inside of each lower leg.



- 4 Soak new foam rings in RockShox® 15wt suspension oil. Install the new foam rings into the lower leg.

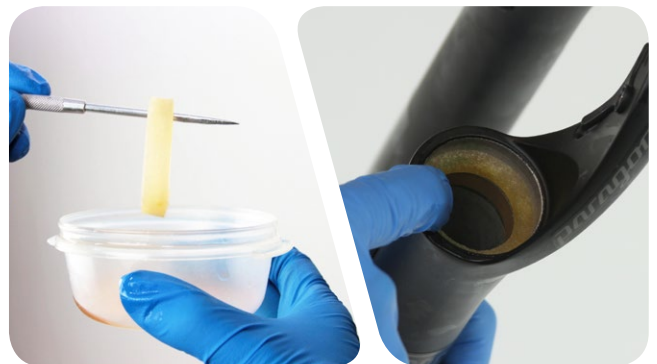

- 5 Remove the outer wire springs from the new dust wiper seals and set them aside.



- 6 Insert the narrow end of a new dust wiper seal into the recessed end of the 28 mm/30 mm RockShox® Dust Seal Installation Tool.



- 7 Hold the lower leg steady and press the dust wiper seal evenly into the lower leg until the seal surface is flush with the top of the lower leg.
Reinstall the outer wire spring.
Apply grease to the inner surface of the dust wiper seal.
Repeat on the other side of the lower leg.

NOTICE

Press the dust wiper seal into the lower leg until it is flush with the top surface of the lower leg.

If a brush is used to apply grease, confirm there are no loose bristles in the grease or on the part.



 To continue with Paragon™ Silver, go to [Paragon Silver](#).

⚠ WARNING - EYE HAZARD

Verify all air pressure is removed from the fork before proceeding. Depress the Schrader valve again to remove any remaining air pressure. Failure to do so can result in injury and/or damage to the fork.

NOTICE

Inspect each part for scratches. Do not scratch any sealing surfaces when servicing your suspension. Scratches can cause leaks.

When replacing seals and o-rings, use your fingers or a pick to remove the seal or o-ring. Spray isopropyl alcohol on each part and clean with a clean lint-free rag.

Apply Liquid-O-Ring® PM600 or SRAM® Butter grease to the new seals and o-rings.

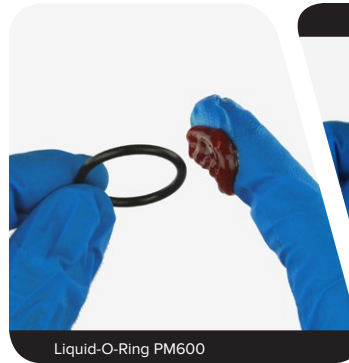

- 1** Unthread and remove the air spring top cap.
Clean the upper tube threads.

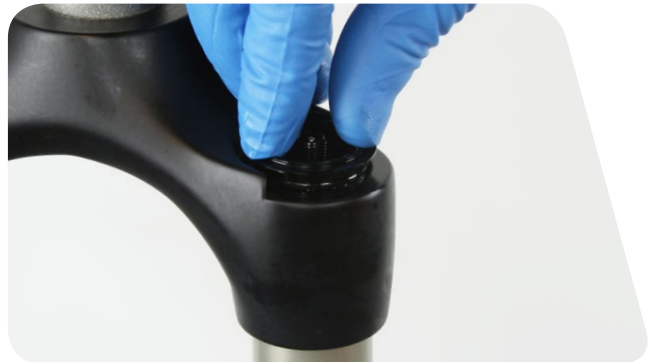
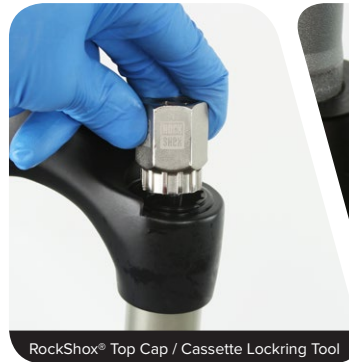

- 2** Push the base plate tab (A) into the upper tube and under the retaining ring.
Remove the retaining ring.

NOTICE

Do not scratch the air spring shaft. Scratches on the air shaft will allow air to bypass the base plate into the lower leg, resulting in reduced spring performance.

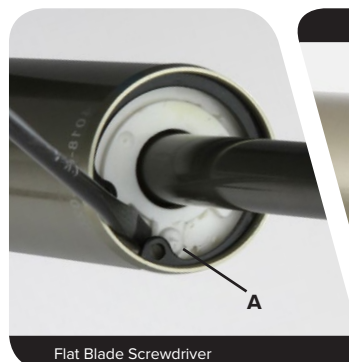

- 3 Remove the air spring assembly from the upper tube.

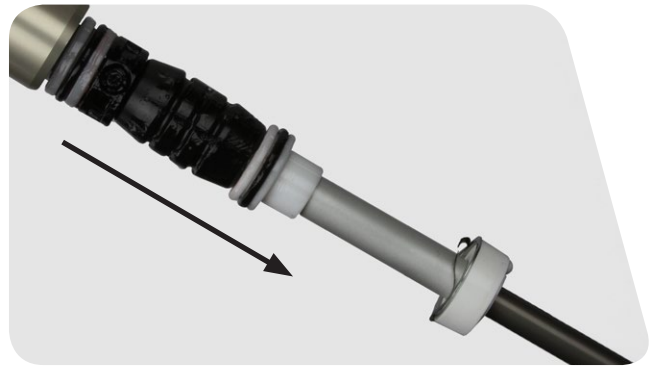

- 4 Spray isopropyl alcohol on the inside and outside of the upper tube.
Clean the inside and outside of the upper tube.
Inspect the inside and outside of the upper tube for scratches.

NOTICE

Scratches on the inside surface of the upper tube can cause air to leak. If an internal scratch is visible, the crown steerer upper tube assembly may need to be replaced.



- 5 Remove the negative air piston assembly from the shaft.



- 6 Remove and discard the positive air piston o-ring.
Spray isopropyl alcohol on the shaft and air piston, and clean them with a rag.
Apply grease to the new o-ring and install it onto the air piston.

NOTICE

Do not scratch the air piston. Scratches will cause air to leak.



- 7** Remove the top out bumper, and the 15 mm All-Travel spacer if originally equipped, from the negative air piston.



- 8** Remove the inner and outer o-rings from the negative air piston and discard them.
Apply grease to the new o-rings and install them onto the negative air piston.

NOTICE

Do not scratch the negative air piston. Scratches will cause air to leak.



Solo Air™ Spring Installation

- 1 Install the top out bumper, and the 15 mm All-Travel spacer if originally equipped or added to reduce travel to 50 mm, onto the negative air piston.



- 2 Apply grease to the air shaft.
Install the negative air piston assembly onto the air shaft. Slide it toward the positive air piston until it stops.



- 3 Apply grease to the inside of the upper tube approximately 60 mm into the tube.



- 4 Insert the air spring assembly into the upper tube. Firmly push the positive and negative air pistons into the upper tube.
Position the flat base plate washer (A) into the upper tube, followed by the wavy washer (B).
Use your fingers to firmly press the base plate (C) into the upper tube until it stops.
Make sure the shaft remains fully extended.



- 5** Retaining rings have a sharper-edged side and a rounder-edged side. Installing retaining rings with the sharper-edged side facing the tool will allow for easier installation and removal.

Position the retaining ring into the bottom of the upper tube retaining ring groove. The base plate tab should be positioned between the retaining ring eyelets.

Place the tips of the large internal retaining ring pliers into the eyelets of the retaining ring, then use the pliers to push the seal head into the upper tube while installing the retaining ring into the groove.

Use your finger and thumb to hold the retaining ring in place while seating the retaining ring eyelets on either side of the seal head tab.

NOTICE

Do not scratch the air spring shaft. Scratches on the air shaft will allow air to bypass the seal head into the lower leg, resulting in reduced spring performance.

Confirm the retaining ring is properly seated in the retaining ring groove by using the retaining ring pliers to rotate the retaining ring and base plate back and forth a few times, then firmly pull down on the shaft.

- 6** Remove the air top cap o-ring and discard it.
Apply grease to the new o-ring and install it onto the top cap.
Apply a small amount of grease to the top cap threads.

NOTICE

Do not scratch the top cap. Scratches will cause air to leak.

- 7** Inject or pour 3-6 mL of RockShox® 5wt suspension oil into the air spring upper tube.

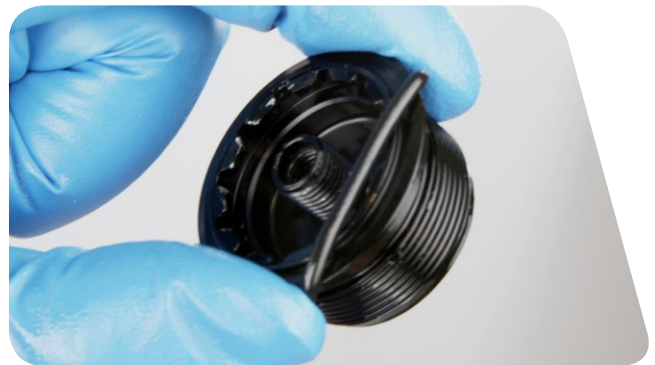

- 8 Install the air top cap and thread it into the upper tube by hand.
Tighten the top cap to the specified torque.

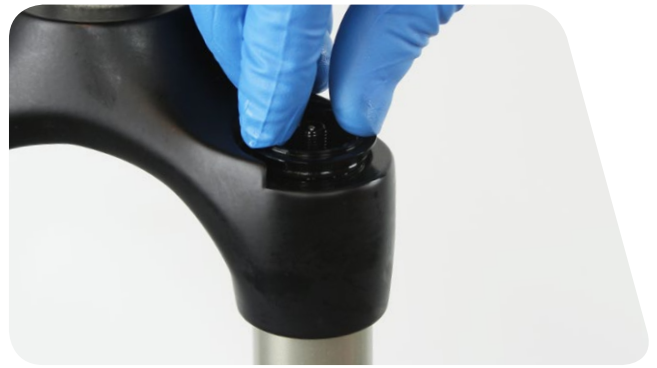

Compression Damper Removal and Service

Service procedures are the same for Motion Control™ and Turnkey™ dampers. Depending on the model and year of your fork, the appearance of the dampers may differ from the appearance of the dampers pictured.

1a Crown Adjust: Rotate the adjuster knob counter-clockwise to the open position.

Remove the faceplate from the adjuster knob, and discard it.



Remove any adhesive residue from the knob with isopropyl alcohol.



Remove the knob retaining screw, and remove the knob.



1b Remote Adjust: Remove the spool retaining screw, and remove the remote spool.



- 2 Unthread the compression damper top cap.



- 3 Remove the compression damper by pulling up firmly and slowly, while gently rotating the damper in a circular motion.

NOTICE

Do not force the damper out of the upper tube if there is resistance. This can cause separation of the piston from the damper tube.



Remote Adjust: Remove the cable stop from the damper.



- 4 Remove the top cap and damper piston o-rings and discard them. Apply grease to the new o-rings and install them onto the top cap and piston.



- 5 Remove the fork from the bicycle work stand and pour the suspension oil into an oil pan.



Rebound Damper Removal and Service

- 1 Clamp the fork back into the bicycle work stand.
Push the rebound damper shaft into the upper tube and remove the retaining ring with retaining ring pliers.

NOTICE

Do not scratch the rebound damper shaft. Scratches will allow oil to leak into the lower leg, resulting in reduced damping performance.



- 2 Remove the rebound damper and seal head from the upper tube.



- 3 Clean the inside and outside of the upper tube.
Inspect the inside and outside of the upper tube for scratches.

NOTICE

Scratches on the inside surface of the upper tube can cause oil to leak. If an internal scratch is visible the crown steerer upper tube assembly may need to be replaced.



- 4 Remove the seal head from the rebound damper shaft.
Clean the rebound damper shaft, and inspect the shaft for scratches.

NOTICE

Scratches on the shaft can cause oil to leak. If a scratch is visible, the rebound damper may need to be replaced.



- 5** Remove the inner and outer seal head o-rings and discard them.
Apply grease to the new o-rings and install them onto the seal head.

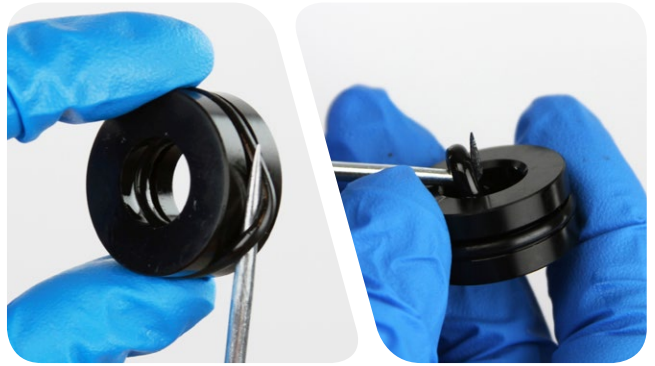

- 6** Remove the glide ring and discard it.
Install a new glide ring onto the piston.



- 7** Install the seal head onto the rebound damper shaft.

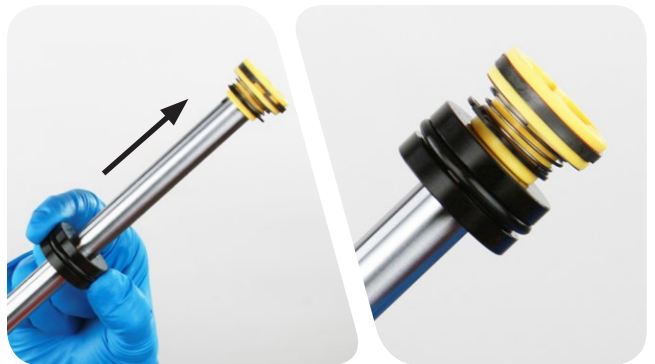

Rebound Damper Installation

- 1** Insert the rebound damper and seal head into the upper tube.
Push the seal head into the upper tube until the retaining ring groove is visible.

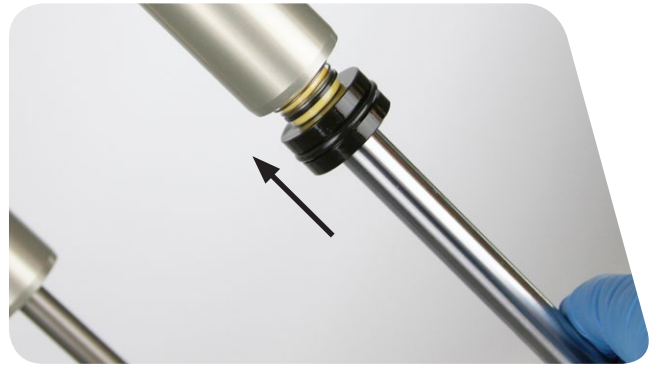

- 2** *Retaining rings have a sharper-edged side and a rounder-edged side. Installing retaining rings with the sharper-edged side facing the tool will allow for easier installation and removal.*

Push the rebound damper shaft into the upper tube to prevent it from getting scratched while installing the retaining ring.

Install the retaining ring into the upper tube groove.

NOTICE

Do not scratch the rebound damper shaft. Scratches will allow oil to leak into the lower leg, resulting in reduced damping performance.

Confirm the retaining ring is properly seated in the retaining ring groove by using the retaining ring pliers to rotate the retaining ring and seal head back and forth a few times.



- 3** Pull the rebound damper shaft out to the fully extended position.

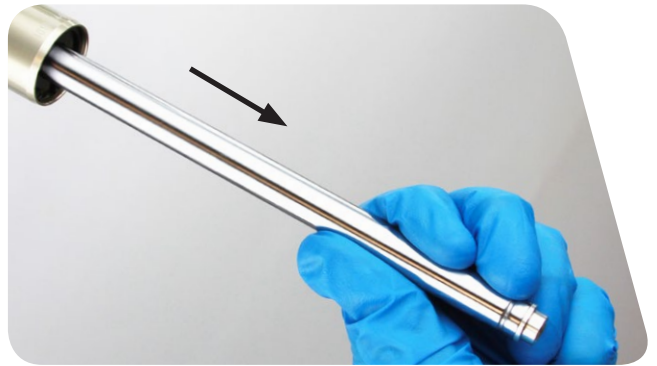

Compression Damper Installation

- 1 Pour RockShox® 5wt suspension oil into the upper tube.

NOTICE

Suspension oil volume is critical. Too much suspension oil reduces available travel and can damage the fork. Too little suspension oil decreases damping performance.

2016	Model	Suspension Oil	Volume (mL)
Paragon™ Gold	TK	5wt	87

2017-2019	Model	Suspension Oil	Volume (mL)
Paragon Gold	RL	5wt	87



- 2 **Crown Adjust:** Use the compression adjuster knob to turn the hex compression rod (A) counter-clockwise to open (B) the valve.

A closed compression valve will restrict oil flow during installation.



- 3 **Remote Adjust:** Insert the compression damper through the cable stop.



4 Insert the compression damper into the upper tube. Press down slowly and rotate in a circular motion until the damper is installed.

Remote Adjust: Position the remote cable stop to the forward position (A).

Thread the top cap into the upper tube.



5 Tighten the top cap to the specified torque.



6 Remote Adjust: Install the remote spool with the cable set screw (A) in the 9 o'clock position.

Install and tighten the spool retaining screw to the specific torque.

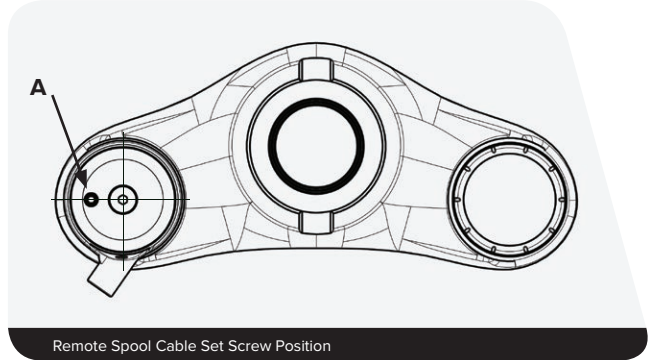

Crown Adjust: Install the adjuster knob with the tab toward the front of the crown (open position).

Install and tighten the knob retaining screw to the specified torque.

Orient the small notch (B) on the new faceplate decal to the middle of the tab on the knob, then press firmly to adhere the faceplate to the knob.

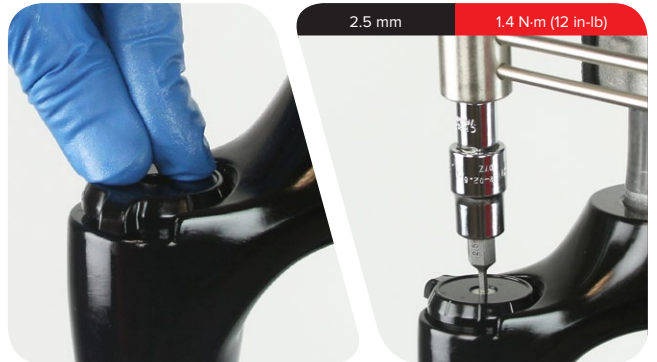

 To continue with Paragon™ Gold service, go to [Lower Leg Installation](#).

NOTICE

Inspect each part for scratches. Do not scratch any sealing surfaces when servicing your suspension. Scratches can cause leaks.

When replacing seals and o-rings, use your fingers or a pick to remove the seal or o-ring. Spray isopropyl alcohol on each part and clean with a clean lint-free rag.

Apply Liquid-O-Ring® PM600 or SRAM® Butter grease to the new seals and o-rings.

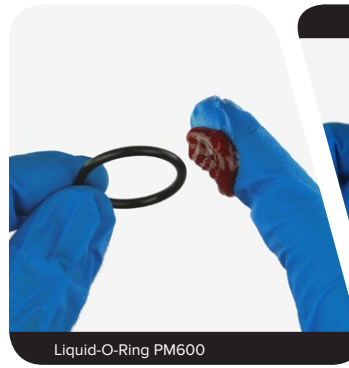

Coil Spring Removal and Service

1 Unthread and remove the top cap cover.



2 Unthread and remove the coil spring top cap.
Clean the upper tube threads.



3 Remove the preload information disc from the top cap.

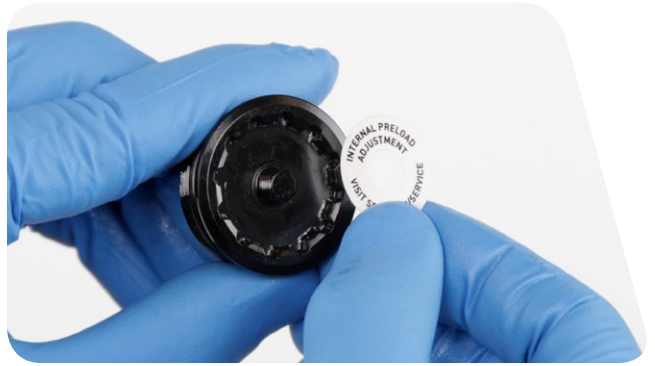

4 Remove the preload spacer and spring assembly from the upper tube.



5 Remove the spring spacer from the spring.
Remove the spring spacer o-ring and discard it. Apply grease to the new o-ring and install it onto the spacer.



- 6 Spray isopropyl alcohol onto the spring, as well as the inside and outside of the upper tube, and clean them.



- 7 Cut and remove the spring isolator from the spring.

⚠ WARNING

To avoid injury, cut in the direction away from your body keeping fingers out of the cutting line.



- 8 Position a new spring isolator onto the center of the spring and hold the spring level to the ground. Use a heat gun to apply heat to the isolator evenly side to side, while slowly rotating the spring, until the isolator shrinks onto the spring uniformly.

⚠ WARNING

To avoid skin burns, allow the spring and spring isolator to cool before continuing.



- 9 Apply a liberal amount of grease to the spring and spring isolator.



Coil Spring Installation

- 1** Install the coil spring assembly into the upper tube and insert the shaft through the shaft guide.

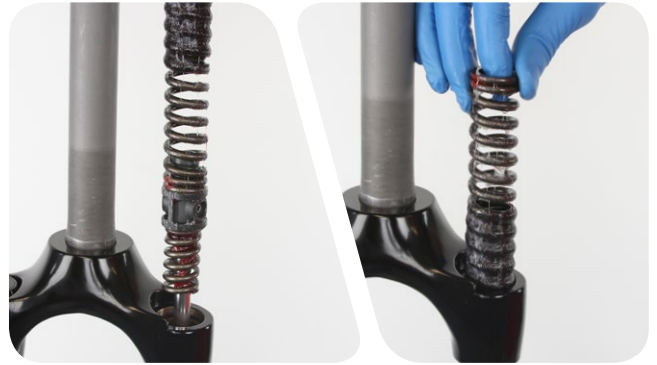

- 2** Install the spring spacer onto the spring.



- 3** Install the preload spacer onto the spring spacer.



- 4** Insert the preload information disc onto the top cap.
Insert the top cap into the upper tube.



Push the top cap down firmly to engage the threads and thread the top cap into the upper tube.



RockShox® Top Cap / Cassette Lockring Tool

- 5** Tighten the top cap to the specified torque.



12.4 N·m (110 in-lb)

- 6** Install the top cap cover.



Compression Damper Removal and Service

1a Crown Adjust: Rotate the adjuster knob counter-clockwise to the open position.

Use a pick and a flat blade screwdriver to remove the faceplate from the adjuster knob, and discard it.



Remove any adhesive residue from the knob with isopropyl alcohol.



Remove the knob retaining screw, and remove knob.



1b Remote Adjust: Remove the spool retaining screw, and remove the remote spool.



- 2 Unthread the compression damper top cap.



- 3 Remove the compression damper by pulling up firmly and slowly, while gently rotating the damper in a circular motion.

NOTICE

Do not force the damper out of the upper tube if there is resistance. This can cause separation of the piston from the damper tube.



Remote Adjust: Remove the cable stop from the damper.



- 4 Remove the top cap and piston o-rings and discard them. Apply grease to the new o-rings and install them onto the top cap and piston.



- 5 Remove the fork from the bicycle work stand and pour the suspension oil into an oil pan.



Rebound Damper Removal and Service

- 1 Clamp the fork back into the bicycle work stand and orient the upper tubes upward at an angle.

Push the rebound damper shaft into the upper tube and through the shaft guide. The damper will slide through the upper tube and exit through the crown into your hand.

Clean the rebound damper shaft with isopropyl alcohol and a rag, and inspect it for scratches.

NOTICE

Scratches on the shaft can cause oil to leak. If a scratch is visible the rebound damper may need to be replaced.



- 2 Remove the glide ring and discard it.
Install a new glide ring.



- 3 Carefully remove the seal head retainer with a flat blade screwdriver.

NOTICE

Do not damage the retainer during removal. Damage will prevent it from staying attached when reinstalled. If damaged during removal, the retainer must be replaced.



- 4 Use a screwdriver handle to firmly push the seal head into the upper tube.



- 5 Push the seal head into and out of the upper tube through the crown with a long dowel.

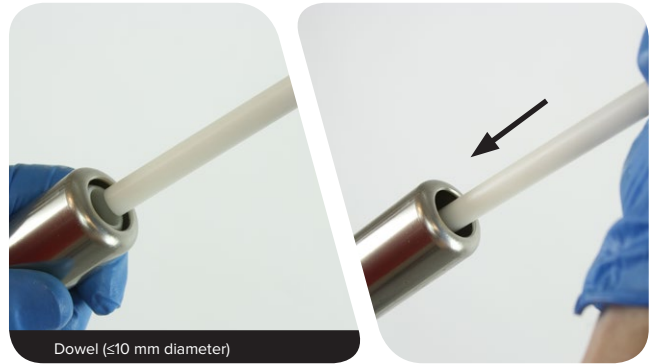

- 6 Remove the inner and outer seal head o-rings and discard them. Apply grease to the new o-rings and install them onto the seal head.

NOTICE

Do not scratch the sealing surfaces. Scratches cause oil to leak.

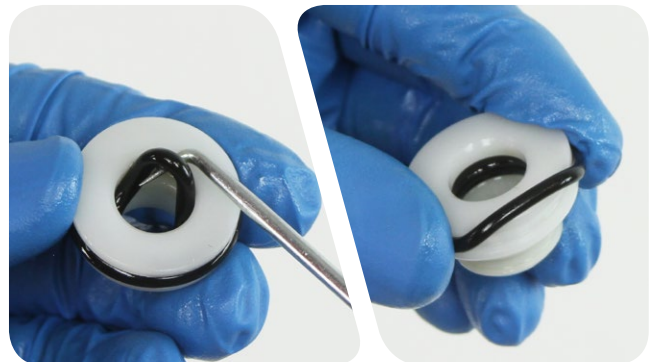

- 7 Spray isopropyl alcohol on the inside and outside of the upper tube.
Clean the inside and outside of the upper tube.

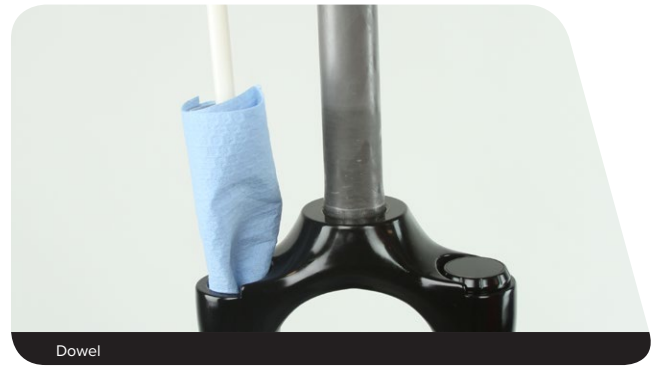

Rebound Damper Installation

- 1** Apply grease to the upper tube threads.
Insert the seal head into the upper tube through the crown, and push it down just below the upper tube threads. Use a dowel if needed.



- 2** Push the seal head down to the end of the upper tube until it is seated into place.



- 3** While pushing the dowel down firmly against the seal head to secure it, use the palm of your hand to press the retainer onto the end of the seal head until it snaps into place.



Confirm the retainer is installed securely.



- 4** Insert a long thin dowel (≤ 10 mm diameter) through the seal head (A) into the upper tube, and through the crown.

The dowel will be used to guide the rebound damper shaft through the seal head as the damper is pushed into the upper tube.

Place the end of the rebound damper onto the end of the dowel and insert the rebound damper shaft into the upper tube.

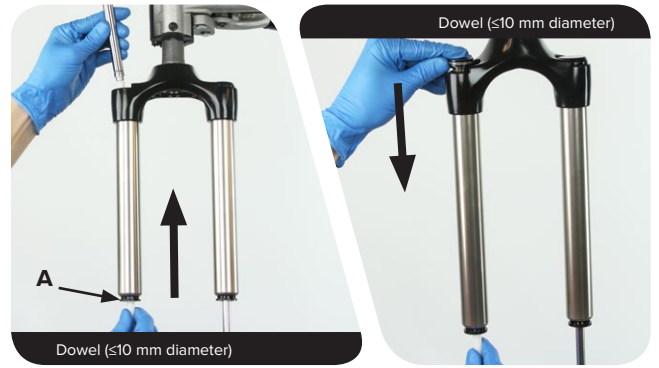

- 5** Push the rebound damper piston into the upper tube.

Hold the dowel in place and apply light pressure to the rebound damper as it is being inserted into the upper tube.

Push the damper into the upper tube while guiding it through the seal head with the dowel.



Pull the damper downward until it stops.

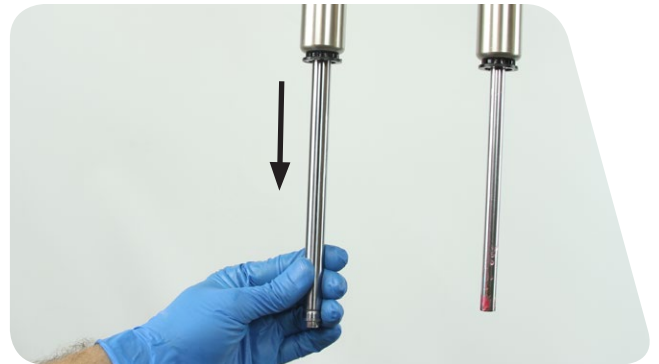

Compression Damper Installation

- 1 Pour RockShox® 5wt suspension oil into the damper side upper tube.

NOTICE

Suspension oil volume is critical. Too much suspension oil reduces available travel and can damage the fork. Too little suspension oil decreases damping performance.

2016 - 2019	Model	Suspension Oil	Volume (mL)
Paragon™ Silver	TK	5wt	100



- 2 **Crown Adjust:** Use the compression adjuster knob to turn the hex compression rod (A) counter-clockwise to open the valve.

A closed compression valve will restrict oil flow during installation.



- 3 **Remote Adjust:** Insert the compression damper through the cable stop.

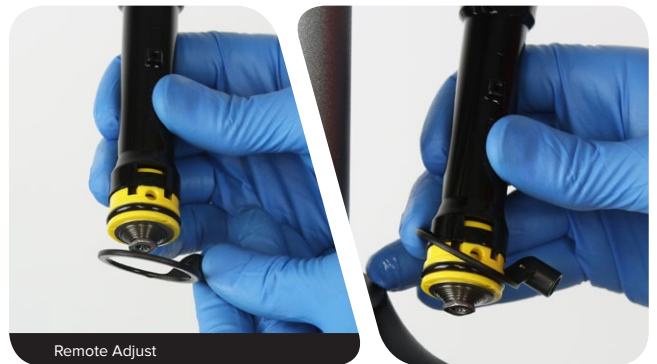

4 Insert the compression damper into the upper tube. Press down slowly and rotate in a circular motion until the damper is installed.

Remote Adjust: Position the remote cable stop to the forward position. Thread the top cap into the upper tube.



5 Tighten the top cap to the specified torque.



6 Remote Adjust: Install the remote spool with the cable set screw (A) in the 9 o'clock position.

Install and tighten the spool retaining screw to the specific torque.

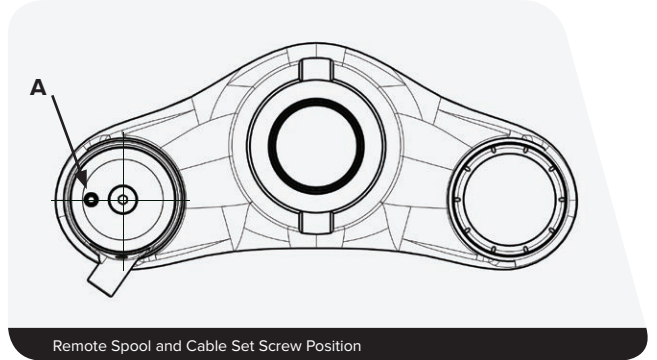

Crown Adjust: Install the adjuster knob with the tab toward the front of the crown (open position).

Install and tighten the knob retaining screw to the specified torque.

Orient the small notch (B) on the new faceplate decal to the middle of the tab on the knob, then press firmly to adhere the faceplate to the knob.



Lower Leg Installation

- 1 Clean the upper tubes.



- 2 Orient the upper tubes upward at an angle.
Install the lower leg assembly onto the upper tubes and slide it just enough to engage the upper bushings with the upper tubes.

NOTICE

Make sure both wiper seals slide onto the tubes without folding the outer lip of either seal.



The inside bottom of the lower leg should not contact the spring or damper shafts. A gap (A) between the shaft ends and the lower leg bolt holes should be visible.

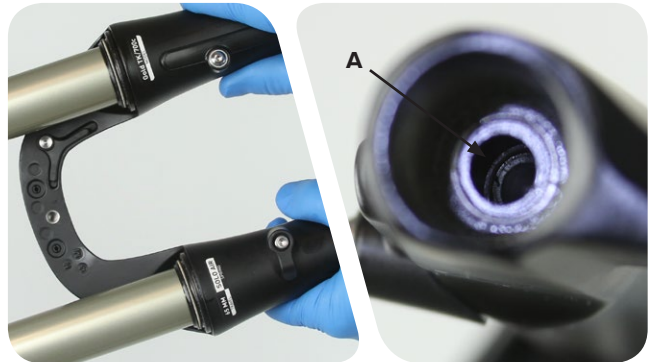

- 3 Inject RockShox® 15wt suspension oil into each lower leg through the bottom bolt holes.

NOTICE

Do not exceed the recommended oil volume per leg as this can damage the fork.

2016 - 2019	Spring	Suspension Oil	Damper Side	Spring Side
			Volume (mL)	
Paragon™ Gold	Solo Air™	15wt	12	12
Paragon Silver	Coil			



- 4 Slide the lower leg assembly toward the crown until it stops.



The spring and damper shafts (A) should be visible through the bottom bolt holes.

Verify each shaft is centered and seated in the lower leg shaft/bolt hole and no gap is visible between the lower leg and the shaft end.



- 5 Unthread the crush washers from each bottom bolt and discard them. Install a new crush washer onto each bolt.

NOTICE

Dirty or damaged crush washers can cause oil to leak from the fork.

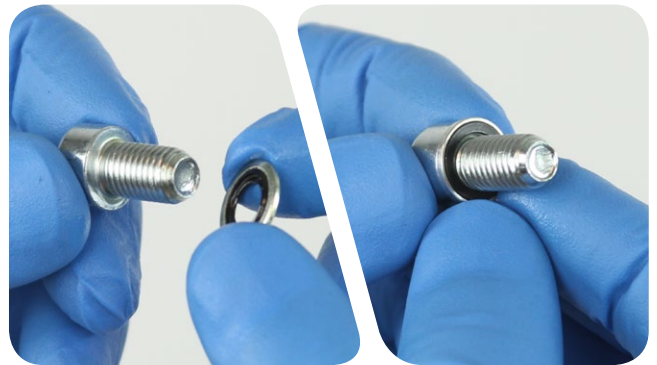

- 6 Install and tighten each bottom bolt to the specified torque.

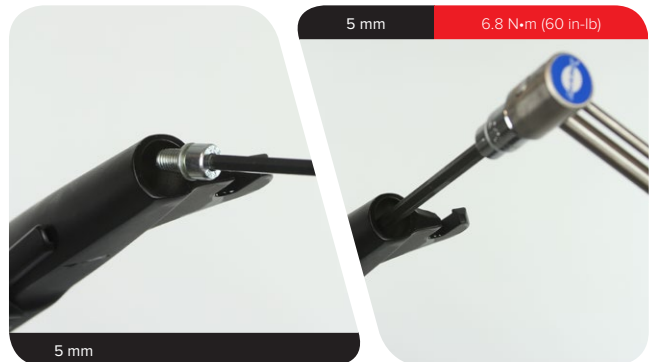

Pressurize and Clean

- 1 Paragon™ Gold:** Refer to the air chart on the fork lower leg for the recommended air pressure and pressurize the air spring.

You may see a drop in indicated air pressure on the pump gauge while filling the air spring, this is normal. Continue to fill the air spring to the suggested air pressure.

Install the air valve cap.



- 2** Spray isopropyl alcohol onto the entire fork and clean it with a rag.



This concludes service for RockShox® Paragon front suspension forks.

This publication includes trademarks and registered trademarks of the following companies:

Liquid-O-Ring® is a registered trademark of Oil Center Research, Inc

SRAM[®]

www.sram.com



ASIAN HEADQUARTERS

SRAM Taiwan
No. 1598-8 Chung Shan Road
Shen Kang Hsiang, Taichung City
Taiwan R.O.C.

WORLD HEADQUARTERS

SRAM LLC
1000 W. Fulton Market, 4th Floor
Chicago, Illinois 60607
USA

EUROPEAN HEADQUARTERS

SRAM Europe
Paasbosweg 14-16
3862ZS Nijkerk
The Netherlands