

Dealer's Manual

ROAD	MTB	Trekking
City Touring/ Comfort Bike	URBAN SPORT	E-BIKE

Crankset with Power Meter

DURA-ACE

FC-R9200-P
BB-R9100

ULTEGRA

FC-R8100-P
SM-BBR60
SM-BB72-41B

SHIMANO

SM-BB92-41B

Contents

IMPORTANT NOTICE.....	3
TO ENSURE SAFETY.....	4
List of tools to be used	10
Installation / removal	11
Installing / removing the bottom bracket	11
Installing the magnet	19
Installing the crank	21
Charging the battery	28
Charging procedures	28
How to operate.....	30
Startup / checking the startup.....	30
Wireless functions	31
Zero offset calibration	33
Maintenance.....	36
Replacing the chainring.....	36
Replacing the control unit cover.....	37
Troubleshooting	39
Introduction	39
Hardware reset.....	41
Connection and communication with devices.....	42
Specifications	43



IMPORTANT NOTICE

- This dealer's manual is intended primarily for use by professional bicycle mechanics. Users who are not professionally trained for bicycle assembly should not attempt to install the components themselves using the dealer's manuals. If any part of the information on the manual is unclear to you, do not proceed with the installation. Instead, contact your place of purchase or a distributor for assistance.
- Make sure to read all manuals included with each product.
- Do not disassemble or modify the product other than as stated in the information contained in this dealer's manual.
- All manuals and technical documents are accessible online at <https://si.shimano.com> .
- For consumers who do not have easy access to the internet, please contact a SHIMANO distributor or any of the SHIMANO offices to obtain a hardcopy of the user's manual.
- Please observe the appropriate rules and regulations of the country, state or region in which you conduct your business as a dealer.
- The Bluetooth[®] word mark and logos are registered trademarks owned by the Bluetooth SIG, Inc. and any use of such marks by SHIMANO INC. is under license. Other trademarks and trade names are those of their respective owners.
- ANT and ANT+ are trademarks or registered trademarks of ANT Wireless.

For safety, be sure to read this dealer's manual thoroughly before use, and follow it for correct use.

The following instructions must be observed at all times in order to prevent personal injury and physical damage to equipment and surroundings.

The instructions are classified according to the degree of danger or damage which may occur if the product is used incorrectly.

 DANGER	Failure to follow the instructions will result in death or serious injury.
 WARNING	Failure to follow the instructions could result in death or serious injury.
 CAUTION	Failure to follow the instructions could cause personal injury or physical damage to equipment and surroundings.

TO ENSURE SAFETY

DANGER

Be sure to also inform users of the following:

- Use the dedicated charging cable when charging the battery. If any non-specified items are used, fire, overheating, leakage, or damage to the connected PC may occur.
- Do not get the charging cable wet and do not touch or hold it while it is wet or with wet hands. If this is not observed, problems with operation or electric shocks may occur.
- Use an AC adapter with a USB port with a voltage of 5.0 V DC and with a current equal to or higher than 0.5 A DC. If one with a current lower than 0.5 A is used, the AC adapter may heat up, potentially causing a fire, smoke, overheating, destruction, electric shock, or burns.
- Do not heat the battery or expose it to flames. If this is not observed, combustion or bursting of the battery may occur.
- Do not use or leave the battery in hot and humid places such as where the battery is exposed to direct sunlight, in a closed vehicle on a hot day, or near a heater. If this is not observed, leakages, overheating or bursting may cause fire, burns or other injury to occur.
- Do not deform, modify, disassemble, or apply solder directly to the battery. If this is not observed, leakages, overheating or bursting may cause fire, burns or other injury to occur.
- Do not touch the metal terminals with metal items such as hairpins. If this is not observed, short-circuits, overheating, burns or other injuries may occur.
- If any liquid leaking from the battery gets into the eyes, immediately wash the affected area with clean water without rubbing the eyes, then seek medical attention. If this is not done, blindness may occur.
- If the battery does not become fully charged after 4 hours of charging, stop charging. If this is not observed, fire, bursting, ignition, or overheating may occur.
- Do not place this product in water, and do not allow the terminals to get wet. If this is not observed, fire, bursting, ignition, or overheating may occur.

WARNING

- Be sure to follow the instructions provided in the manuals when installing the product.
Only use SHIMANO genuine parts. If a component or replacement part is incorrectly assembled or adjusted, it can lead to component failure and cause the rider to lose control and crash.
-  Wear approved eye protection while performing maintenance tasks such as replacing components.

Be sure to also inform users of the following:

- Clean the chain and QUICK-LINK with an appropriate chain cleaner regularly. Intervals between maintenance depend on the use and riding circumstances. Never use alkali- or acid-based solvents such as rust cleaners. If those solvents are used the chain or QUICK-LINK might break and cause serious injury.
- Check that there are no cracks in the crank arms before riding the bicycle. If there are any cracks, the crank arm may break and you may fall off the bicycle.
- Be careful not to let the hemming of your clothes get caught in the chain while riding. Otherwise, you may fall off the bicycle.
- Check the chain for any damage (deformation or cracking), skipping, or other abnormalities such as unintended gear shifting. If any problems are found, consult your place of purchase or a distributor. The chain may break, and you may fall.
- When connecting or disconnecting the charging cable, be sure to hold the cable by the plug. Failure to do so may cause a fire or electric shock.
- If the following symptoms are observed, stop using the device and contact your place of purchase. A fire or electric shock may be caused.
 - * If heat, acrid-smell, or smoke is coming out from the power plug.
 - * There may be a bad connection inside the power plug.
- If it thunders while charging with an AC adapter with a USB port, do not touch the device, bicycle, or the AC adapter. If lightning strikes, electric shocks may occur.
- Do not use a USB hub when connecting the cable to a PC USB port. This may cause a charging error or fire due to overheating.
- Be careful not to damage the charging cable. (Do not damage, modify, forcibly bend, twist or pull it, put it near hot objects, place heavy objects on it or bundle it tightly together.) If it is used while damaged, fire, electric shocks or short-circuits may occur.
- The operating temperature ranges for the battery are given below. Do not use it in temperatures outside these ranges. If a battery is used or stored in temperatures which are outside these ranges, fire, injury or problems with operation may occur.
(1) During discharge: -10°C - 50°C

TO ENSURE SAFETY

(2) During charging: 0°C - 45°C

- Do not throw or subject this product to strong shocks. If this is not observed, bursting, overheating or problems with operation may occur.
- Be careful not to get grease, etc., on the metal terminals. A conduction failure may result.
- Do not use the battery if leakages, discoloration, deformation or any other abnormalities occur. If this is not observed, bursting, overheating or problems with operation may occur.
- If any leaked fluid gets on your skin or clothes, wash it off immediately with clean water. The leaked fluid may damage your skin.
- Keep magnetic cards, medical devices, electronic devices, precision instruments, etc., away from the magnet included with this product. Data loss or malfunctioning may result.
- This product contains a powerful magnet and should be handled with care. There is a risk of your hand or fingers being caught and injured.

■ Disposal precautions

- Observe all federal, state and local environmental regulations when disposing of a cycle computer that incorporates a battery. Disposal of this product into fire or a hot oven, or mechanically crushing or cutting of it, can result in an explosion of the internal battery.

For installation to the bicycle and maintenance

- Install the inner cover correctly. If it is not installed correctly, the axle may rust and become damaged, and the bicycle may fall over and serious injury may occur as a result.
- Be sure to use a torque wrench with the specified torque value when tightening the crank mounting screws, and re-check the tightening after riding approximately 100 km. If riding when the tightening torque is weak, the crank could detach and you may fall off the bicycle.
- Re-checking the tightening torque of the crank is necessary when the crank is subjected to strong blows from a fall. If riding when the tightening torque is weak due to a strong blow, the crank could detach and you may fall off the bicycle.

CAUTION



Be sure to also inform users of the following:

- Be careful not to touch the teeth of chainrings. There is a danger of injury.
- Do not leave the charging cable connected when performing maintenance.
- Keep out of reach of children.

NOTICE

Be sure to also inform users of the following:

- Be sure to keep turning the crank arm during the shift lever operation.
- When the chain is in any of the positions shown in the figures, the chain may come into contact with the chainring or front derailleur and generate noise. If noise is a problem, shift the chain onto the next largest sprocket or the one after it.

	Double
Chainring	
Sprocket	

- Check that there is no excess play or looseness in any fastening sections before riding the bicycle. Also, be sure to retighten the cranks and pedals at periodic intervals.
- Use a neutral detergent to clean the crank and the bottom bracket. Using alkaline or acidic detergents may cause discoloration.
- If pedaling performance does not feel normal due to an abnormal noise, etc., contact your place of purchase.
- Do not wash the surrounding area of the bottom bracket with a high-pressure wash. Water may enter the bearing section and cause noise or adhesion.
- If you feel any excess play in the bearing section, the bottom bracket should be replaced.
- The chainrings should be periodically washed with a neutral detergent. In addition, cleaning the chain with neutral detergent and lubricating it can be an effective way of extending the life of the chainrings and the chain.
- The cuffs of your clothing may get dirty from the chain while riding.
- This product is not warrantied against damage caused by improper use, abuse, or issues resulting from a crash, unless the circumstance was caused by a manufacturing fault.
- Do not get the charging cable or connector wet when connecting them.
- Do not keep connecting and disconnecting the small waterproof connector. The waterproof section or the connecting section may become worn or deformed, and the function may be affected.
- The components are designed to be fully waterproofed to withstand wet weather riding conditions; however, do not deliberately place them into water.
- Do not clean the bicycle in a high-pressure wash. Moreover, do not place any components in water. If water gets into any of the components, operating problems or rusting may result.
- Do not use the thinners or harsh solvents to clean the products. Such solvents may damage the surface.
- Contact the place of purchase for updates of the component software. The most up-to-date information is available on the SHIMANO website.

TO ENSURE SAFETY

- Charging can be carried out at any time regardless of the battery level. Always use the dedicated charging cable and charge the battery until it is fully charged.
- The battery is not fully charged at the time of purchase. Before riding, be sure to fully charge the battery.
- When the battery is completely depleted, charge it as soon as possible. If you leave the battery without charging it, it will cause the battery to deteriorate.
- The battery is an exhaustible item. The battery will gradually lose its capacity to charging after repeated use. If the length of time that the battery can be used becomes extremely short, contact the place of purchase or a distributor.
- If the device will not be used for an extended period, store it after charging in cool indoor places (approx. 10°C - 20°C) where the battery will not be exposed to direct sunlight or rain, and charge every six months.
- Store this product or the bicycle with this product installed in a cool indoor location away from direct sunlight and rain (approx. 10°C - 20°C). If the storage temperature is too low or too high, the performance of the battery is reduced, and its usable time will be shorter. When you use it after a long storage period, make sure to charge it first.
- If the ambient temperature is low, the battery's usable time will be shorter.



Disposal information for countries outside the European Union

This symbol is only valid within the European Union.

For information on the disposal of used batteries, contact the place of purchase or a distributor.

- Observe all federal, state and local environmental regulations when disposing of a cycle computer that incorporates a battery. Disposal of this product into fire or a hot oven, or mechanically crushing or cutting of it, can result in an explosion of the internal battery.
- Charge the battery indoors to avoid exposure to rain or wind.
- Do not bundle the charging cable.
- Do not apply excessive tension to the charging cable.
- Do not ride the bicycle while the charging cable is still connected to it.
- E-TUBE PROJECT Cyclist cannot be used while the charging cable is connected.
- Keep away from magnetic objects. If this is not observed, problems with operation may occur. When installing a product that uses a magnet, make sure the magnet is set in the specified location before installing the product.
- Products are not guaranteed against natural wear and deterioration from normal use and aging.
- For maximum performance we highly recommend SHIMANO lubricants and maintenance products.

For installation to the bicycle and maintenance

- When installing the pedals, apply a small amount of grease to the threads to prevent the pedals from sticking. Use a torque wrench to securely tighten the pedals. (Tightening torque: 35 - 55 N·m.) The right crank has a

TO ENSURE SAFETY

right-hand thread, and the left crank has a left-hand thread.

- If the bottom bracket shell is not parallel, gear shifting performance will drop.
- If the chain keeps coming off the gears during use, replace the chainrings and the chain.
- When installing the left- and right-hand cups, apply grease and be sure to install the inner cover. Otherwise, the waterproofing performance will worsen.
- To ensure the best performance, be sure to use only the recommended type of chain.

Crankset	Recommended chain
FC-R9200-P	CN-M9100
FC-R8100-P	CN-M8100

- If a squeaking noise is heard coming from the bottom bracket axle and the left crank arm connector, apply grease to the fastening section, then tighten it to the specified torque.
- Only use chainring combinations listed below. If other chainring combinations are used, it can create poor shifting and cause the chain to jam, resulting in damage to the bicycle.









FC-R9200-P		Top		
		54T-NJ	52T-NH	50T-NK
Low	40T-NJ	X	-	-
	36T-NH	-	X	-
	34T-NK	-	-	X

FC-R8100-P		Top	
		52T-NH	50T-NK
Low	36T-NH	X	-
	34T-NK	-	X







The actual product may differ from the illustration because this manual is intended mainly to explain the procedures for using the product.

List of tools to be used







The following tools are needed for installation, adjustment, and maintenance purposes.

Tool			
	1.5 mm hexagon wrench		Soft face mallet
	5 mm hexagon wrench		Hexalobular [#30]
	8 mm hexagon wrench		TL-FC40
	17 mm spanner		Magnet setting tool

BB-R9100

Tool			
 + 	TL-FC24 & TL-FC32	 + 	TL-FC24 & TL-FC36
 + 	TL-FC24 & TL-FC33		TL-FC34

SM-BBR60

Tool			
 + 	TL-FC25 & TL-FC32	 + 	TL-FC25 & TL-FC36
 + 	TL-FC25 & TL-FC33		TL-FC37

SM-BB92-41B / SM-BB72-41B

Tool			
	TL-BB12		TL-BB13

Installation / removal

Installing / removing the bottom bracket

Tool combination chart

The tools required for installing/removing the bottom bracket differ by model. Combine and use any of the tools specified in the table.

BB-R9100

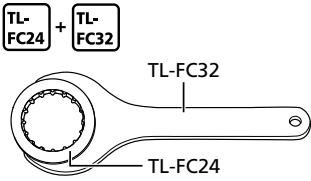
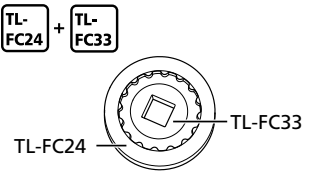
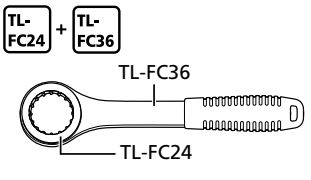
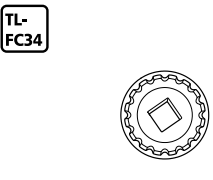

TL-FC24 & TL-FC32	TL-FC24 & TL-FC33
	
TL-FC24 & TL-FC36	TL-FC34
	

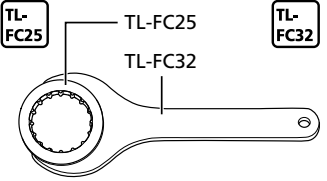
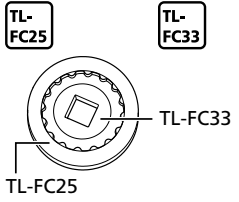
SM-BBR60

TL-FC25 & TL-FC32	TL-FC25 & TL-FC33
	

Installation / removal

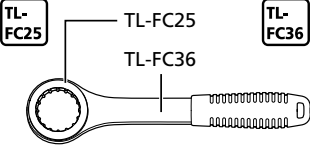
Installing / removing the bottom bracket

TL-FC25 & TL-FC36	TL-FC37
	

NOTICE

- When using an impact wrench on BB-R9100, use it in combination with TL-FC34. Using any other combinations will damage the tool.
- When using an impact wrench on SM-BBR60, use it in combination with TL-FC37. Using any other combinations will damage the tool.
- TL-FC24 / TL-FC25 may become damaged and unusable after repeated use.
- When setting the TL-FC24 or TL-FC25 to the TL-FC32, refer to the markings on the TL-FC24 / TL-FC25 to check the possible installation positions.

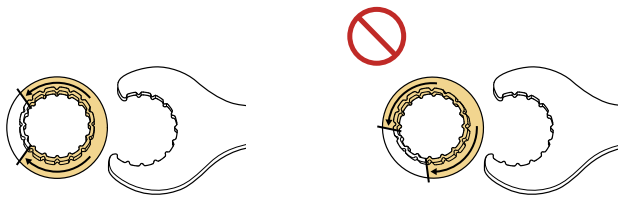

- Any installation position is possible for TL-FC33 / TL-FC36.

Installation / removal

Installing / removing the bottom bracket

Installation

Threaded bottom bracket

1. Install the inner cover, cups, and spacer.

- (1) Apply grease to the left- and right-hand cups.
- (2) Use the SHIMANO original tools (refer to " Tool combination chart " in "Installing/removing the bottom bracket") to tighten the left- and right-hand cups.

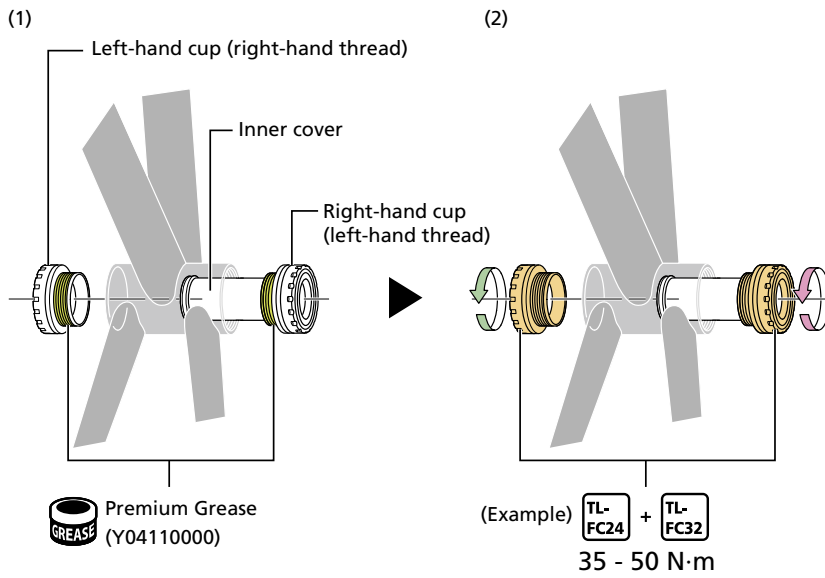

NOTICE

- If it is a 70 mm [M36] bottom bracket, turn the right-hand cup clockwise (right-hand thread).
- Make sure the electric wires exposed in the bottom bracket shell pass around the inner cover of the bottom bracket.

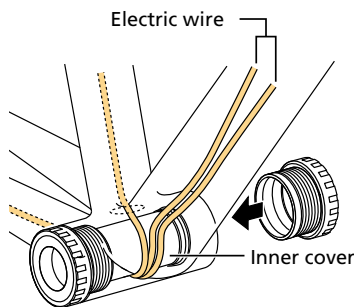

- If using a frame which does not have enough space between the inner wall of the bottom bracket shell and the inner cover to route the electric wires, use an inner cover which is sold separately.

Installation / removal

Installing / removing the bottom bracket

Press-fit bottom bracket

1. Set the bottom bracket in the bottom bracket shell.

- Use a bottom bracket compatible with a shell width of 86.5 mm.
- Set the inner cover and cups.

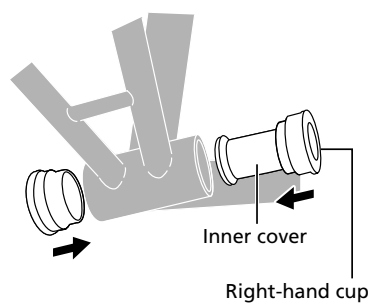
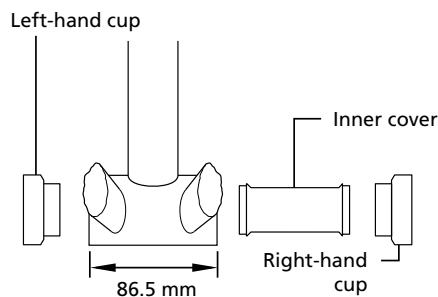

NOTICE

- If the frame has openings for the bottom bracket shell, attach an inner cover to prevent foreign objects from getting inside. If there are no openings, it can be installed without an inner cover.
- Make sure the electric wires exposed in the bottom bracket shell pass around the inner cover of the bottom bracket.

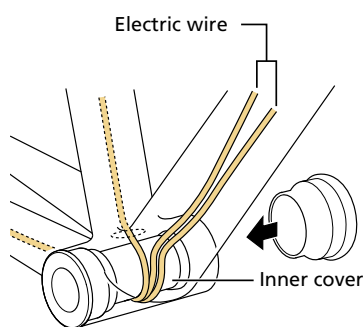

- If using a frame which does not have enough space between the inner wall of the bottom bracket shell and the inner cover to route the electric wires, use an inner cover which is sold separately.

2. Insert the SHIMANO original tool into the bottom bracket.

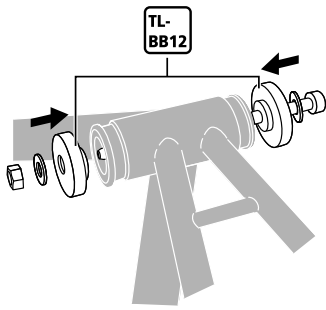

3. Use the specified spanner and hexagon wrench to press-fit the bottom bracket.

Make sure that the contact surface of the bottom bracket is parallel with the contact surface of the bottom bracket shell.

* Press-fit until there is no more gap between the bottom bracket and the bottom bracket shell.

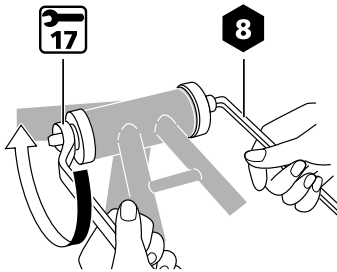

Removal

Threaded bottom bracket

1. Perform the removal in the reverse order from "Installation" in "Installing/removing the bottom bracket."

Press-fit bottom bracket

1. Insert the SHIMANO original tool into the bottom bracket.

- (1) Extend the flaps to taper the tip of the SHIMANO original tool.
- (2) Insert the SHIMANO original tool from the opposite side of the cup you wish to remove.
- (3) As shown in the figure, press down on the protruding portion of the tip with your hand to expand the flaps.
- (4) Push the tool in further while continuing to press down on the tip, until the collar on the flaps engages with the cup.

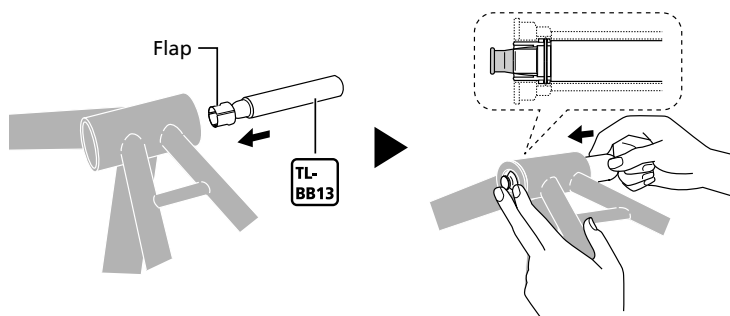

2. Tap the SHIMANO original tool with a soft face mallet to push out the cup.

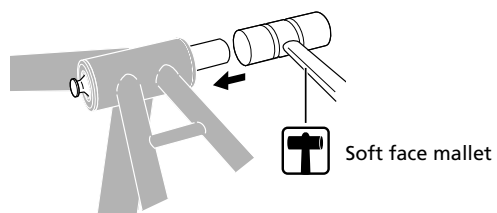

3. Remove the cup on the opposite side in a similar manner.

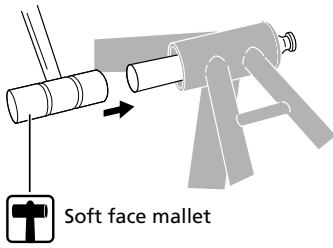

NOTICE

- Do not reuse the cups as they can be damaged during removal.

Installing the magnet

When using the included magnet setting tool, install the bottom bracket first.

1. Combine the cover, magnet, and double-sided tape as shown in the figure.

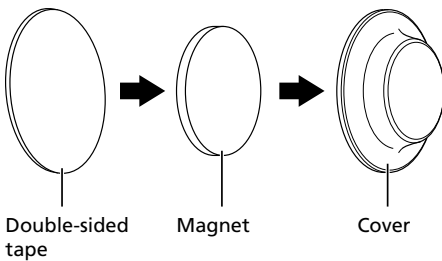

TECH TIPS

- Two covers are provided: black and white. Use the color of your choice.

2. Install the magnet setting tool to the hole in the bottom bracket on the right crank side.

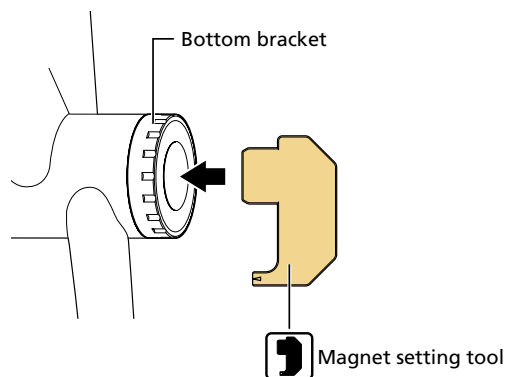

3. Decide the position for affixing the magnet.

- (1) Check that the tip of the tool does not interfere with the magnet, as shown in the figure.
- (2) Check that the distance from the Δ marking on the tool to the surface of the magnet is 5 mm or less, as shown in the figure.

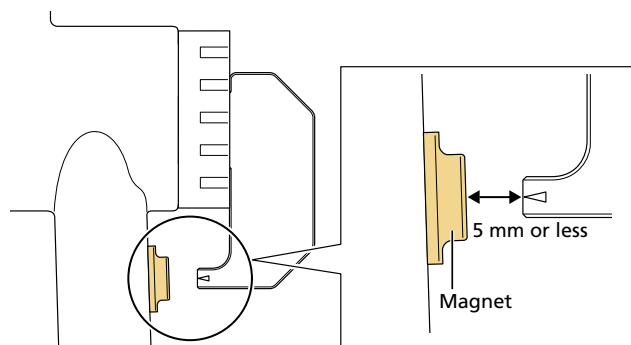

NOTICE

- Affix the magnet to the chainstay, seat tube, or down tube. When affixing it, make sure to check that the following conditions are met:
 - The tip of the tool does not interfere with the magnet
 - The distance from the Δ marking on the tool to the surface of the magnet is 5 mm or less
- Affix the magnet to a flat part of the frame where possible.
- When the position for affixing the magnet is decided, wipe any oil or dirt on the frame clean before affixing the magnet.

4. Affix the magnet.

Check that the Δ marking on the tool is aligned with the center of the magnet, remove the film and affix the magnet.

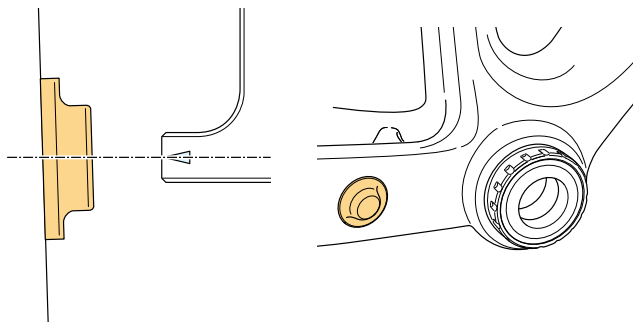

Installing the crank

1. Insert the right crank arm unit without removing the spindle cover.

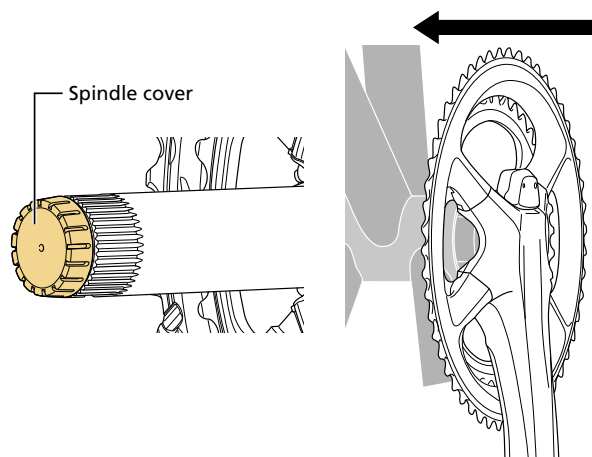

NOTICE

- Do not remove the spindle cover when installing the crank arm unit. Doing so may cause connection problems due to grease, etc. adhering to the terminals inside the axle during insertion.

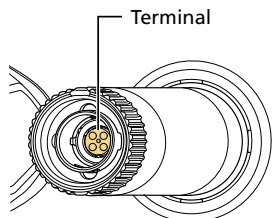

2. Remove the spindle cover.

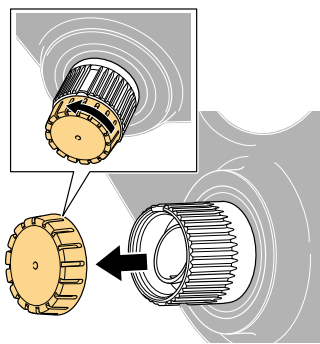

3. Set the left crank arm.

Align the wide parts of the left crank arm and the axle of the right crank arm unit.

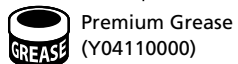
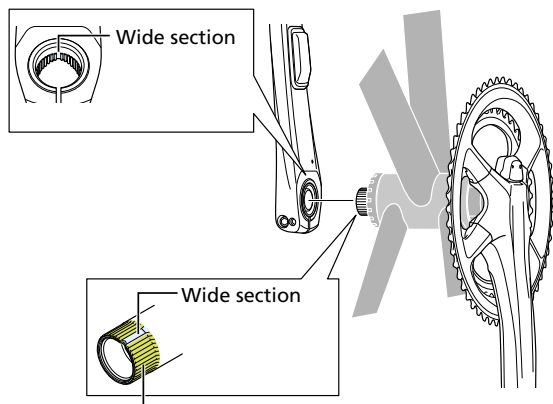

Premium Grease
(Y04110000)

NOTICE

- When applying grease, make sure that grease does not adhere to the inside of the axle.

4. Use the TL-FC40 to install the left crank installation ring.

Secure it in the position where the groove of the tool is aligned with the groove on the top of the crank, as shown in the figure. This ensures that the cable of the connection terminal is in the center of the ring groove.

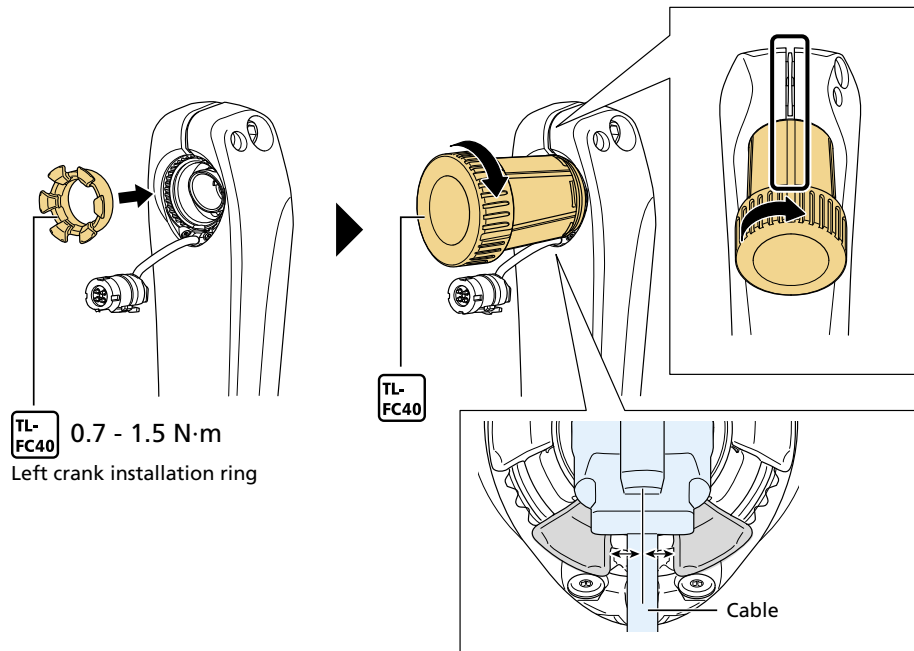

NOTICE

- Make sure to use the TL-FC40 SHIMANO original tool when installing the left crank installation ring.
- When using the SHIMANO original tool, check that the electric wire of the connector is not pinched. Performing tightening with the electric wire pinched may cause the wire to break.

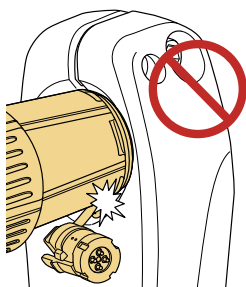

- When aligning the groove of the tool with the groove on the top of the crank, perform adjustment by turning in the tightening direction. Performing adjustment by turning in the loosening direction may cause the crank to become detached due to insufficient torque.

5. Insert the connector so the lever of the connector is on top.

Push it in firmly until you feel a click.

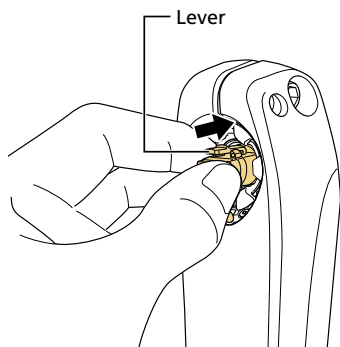

NOTICE

- Before inserting the connector, check that the O-ring is installed inside the crank axle.

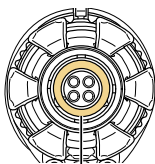

O-ring

- Ensure the correct orientation of the connector. Forcibly pushing it in may damage the connector.
- Do not allow water, oil, or grease, etc. to adhere to the connector.

6. Tighten the mounting screws to secure the crank arm.

- (1) Set the stopper plate in the direction shown in the figure and push it in.
- (2) Check that the plate pin is securely inserted.
- (3) Tighten the left crank arm mounting screws alternately until the 2 screws reach the specified torque.

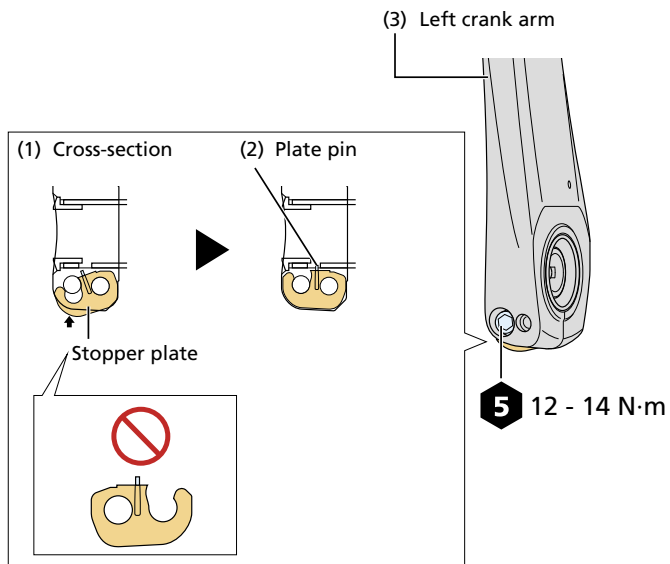

7. Install the outer cap.

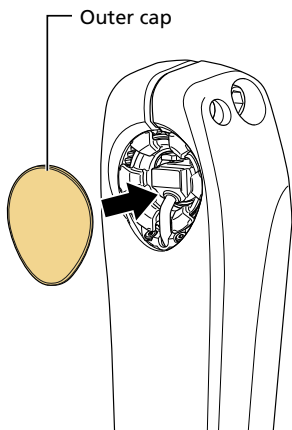

NOTICE

- When installing the outer cap, align the shape of the cap and the installation hole. Forcibly pushing it in may damage the cap.

TECH TIPS

- When removing the outer cap, insert a thin rod such as a hexagon wrench into the groove of the left crank, and lift it up.

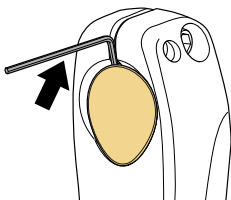

8. Press the button of the control unit and check that the LED lights up green or red.

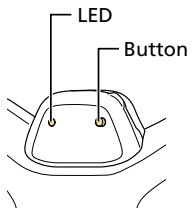

NOTICE

- Make sure to perform this procedure. Otherwise it may not operate correctly.
- If the LED does not light up, refer to the " Charging procedures " section and charge the battery.

Charging the battery

Charging procedures

You cannot use the battery immediately after shipment.

Be sure to charge it before use.

This product can be charged by using an AC adapter with a USB port or by connecting it to the USB connector of a PC.

Power may no longer be supplied to the battery if the PC enters a hibernation or sleep state while charging.

1. Pull the tab on the top of the control unit to open the cover.

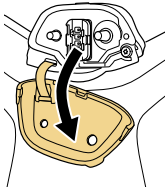

2. Connect the charging cable as shown in the figure.

Align the shape of the charging cable and connection port when connecting the cable.

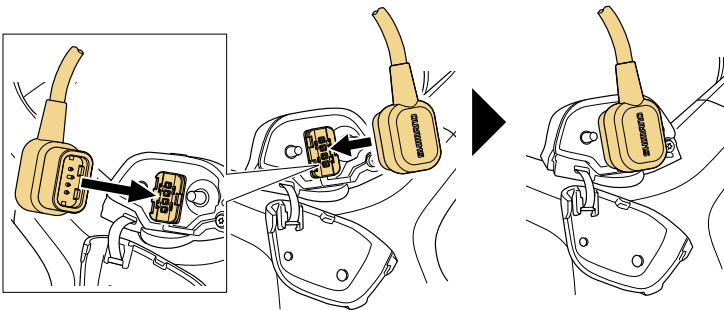

3. The LED lights up blue when charging starts.

Do not move the crank or cable while charging. Doing so may cause the cable to become disconnected. If the cable becomes disconnected, reconnect it.

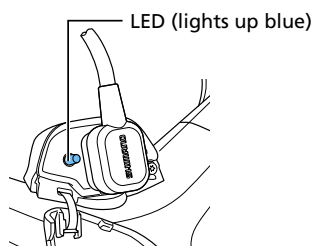

Charging the battery

Charging procedures

4. When charging is complete, the LED turns off.

Be sure to close the cover after charging.

Checking the battery level display

1. Press the button of the control unit.

2. The LED lights up green or red.

If the LED lights up red, is flashing, or does not light up, the battery level is low. Charge the battery.

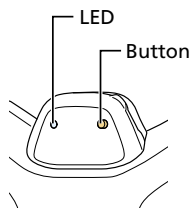

LED	Battery level
● Green	100% - 16%
● Red	15% - 3%
⚡ Flashing red	2% - 1%
● Off	0%

How to operate

Startup / checking the startup

1. Press the button of the control unit or turn the crank twice or more.

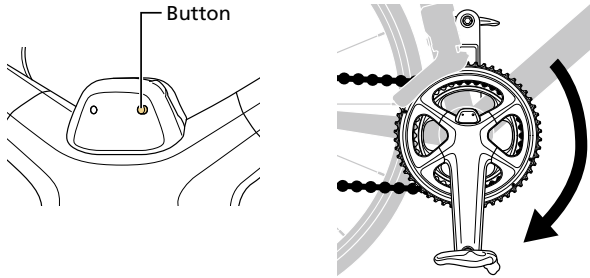

2. Check the startup.

If startup was performed by pressing the button of the control unit

The LED lights up and the battery level is displayed.

If startup was performed by turning the crank

The cadence and power are displayed on the screen of the cycle computer.

NOTICE

- If the LED does not light up
The battery level is insufficient. Refer to the " Charging procedures " section and charge the battery.
- If the cadence and power are not displayed on the screen of the cycle computer
The battery level is insufficient or a wireless connection has not been performed. Press the button of the control unit and check that the LED lights up. If the LED lights up, refer to the " Wireless functions " section and connect wirelessly.

TECH TIPS

- This product automatically stops wireless communication to reduce battery consumption if no operations are detected for five minutes after startup. To reconnect wirelessly, press the button of the control unit or turn the crank twice or more.

Wireless functions

Functions

E-TUBE RIDE / cycle computer connection

This product transmits the following information wirelessly to a cycle computer, receiver, or E-TUBE RIDE installed in a tablet device that supports ANT+™ or Bluetooth® LE connections.

For details on the information displayed, refer to the E-TUBE PROJECT Cyclist user's manual, E-TUBE RIDE user's manual, or the manual for your cycle computer or receiver.

Communication method	Transmission setting	Display item
ANT+	[Bicycle Power]	Power / Cadence / Left/right power balance / Torque effectiveness / Pedal smoothness / Battery level
Bluetooth® LE	[Cycling Power]	Power / Cadence / Left/right power balance / Battery level
ANT+ / Bluetooth® LE	[Force Vector]	Power / Cadence / Left/right power balance / Pedaling efficiency / Force vector / Battery level

TECH TIPS

- You can check the latest functions by using E-TUBE PROJECT Cyclist to update the firmware. For details, refer to the user's manual for E-TUBE PROJECT Cyclist .

E-TUBE PROJECT Cyclist connection

E-TUBE PROJECT Cyclist may be used if a Bluetooth® LE connection is established with a smartphone/tablet.

Connection method

Cycle computer connection

To connect, the cycle computer needs to be in "connection mode." For information on how to put the cycle computer into connection mode, refer to the manual for your cycle computer.

1. **Press the button of the control unit or turn the crank twice or more to start the product.**

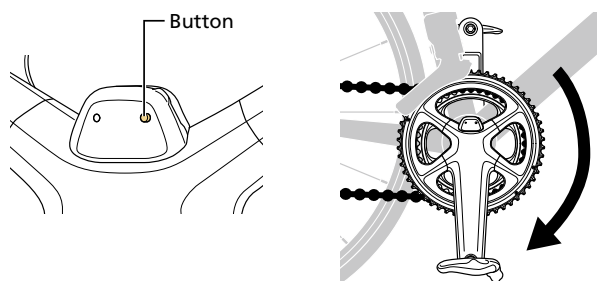

2. **Select the unit name displayed on the cycle computer screen.**

For an ANT+™ connection, you can also connect by entering the five-digit ANT ID found on the inside of the right crank.

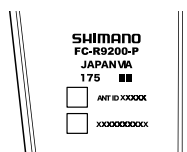

3. **Connection is complete.**

Check on the cycle computer to see if connection has been successful. If connection cannot be performed in the way described above, refer to the manual for your cycle computer.

E-TUBE PROJECT Cyclist / E-TUBE RIDE connection

Before setting up a connection, turn on the Bluetooth® LE function on the smartphone or tablet.

1. **Start the application and set it to listen for Bluetooth LE signals.**

For details on application operations, refer to the user's manual for each application.

- E-TUBE PROJECT Cyclist
- E-TUBE RIDE

2. Press the button of the control unit.

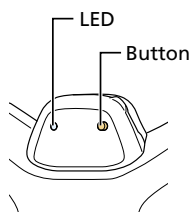

TECH TIPS

- Remove your finger from the button when the battery level is displayed. If the button is held down for any longer, a different mode will be activated.

3. Select the unit name displayed on screen.

NOTICE

- When disconnecting, cancel the Bluetooth[®] LE connection from the smartphone/tablet.
- Holding down the button of the control unit for at least 3 seconds while the battery is charging will revert the configured Bluetooth[®] LE name and Passkey to the default values. The LED will flash blue.

Bluetooth [®] LE name	Default passkey
FCR9200PXXX	000000

* The last three digits of the product serial are displayed for XXX.

Zero offset calibration

The zero offset can be calibrated using the control unit or the cycle computer. For information on setting it using the cycle computer, refer to the manual for the cycle computer.

It is recommended that you calibrate the zero offset before riding the bicycle.

How to operate Zero offset calibration

1. Place the bicycle on a flat surface.

NOTICE

- Do not apply force to the crank when doing so, such as by placing your foot on the pedal. Doing so may prevent the setting from being configured correctly.

2. Position the crank arm so that it is perpendicular to the ground, as shown in the figure.

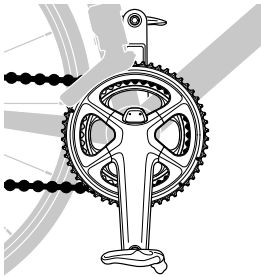

TECH TIPS

- The zero offset calibration is not affected, regardless of whether the chain is on the largest chainring or smallest chainring.

How to operate

Zero offset calibration

3. Hold the button of the control unit until the LED lights up blue.

When the LED lights up blue, release the button.

The LED starts flashing blue, and the zero offset calibration is complete.

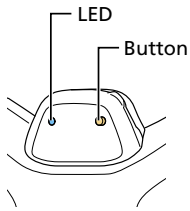

NOTICE

- If the LED flashes red, calibrate the zero offset again.
- When connected to a cycle computer via ANT+™ or connected to E-TUBE PROJECT, "5050" will be displayed on your cycle computer, smartphone, or tablet once the zero offset calibration is complete. If some other number is displayed even if you perform zero offset calibration again, contact the place of purchase or a distributor.

Maintenance

Replacing the chainring

NOTICE

- Gear shifting performance will be reduced if the installation positions of the chainrings are incorrect. Be sure to install the chainrings in the correct positions.
- Make sure to use the correct combination of SHIMANO genuine parts, otherwise the cranks or chainrings may become damaged.

1. Remove the chainrings from the crank arm.
2. Set the largest chainring on the crank arm.

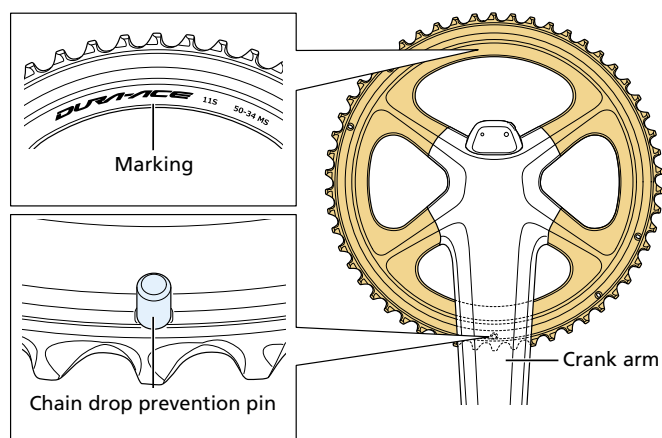

3. Install the smallest chainring.

- (1) With the marked side facing inward, set the smallest chainring so that the Δ marking or alignment tab is positioned under the crank arm.
- (2) Secure it using the chainring mounting screws.

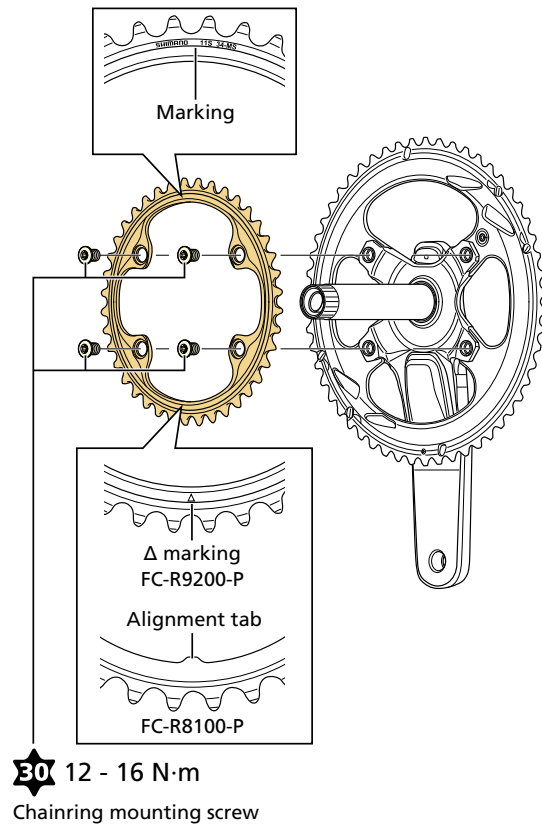

Replacing the control unit cover

1. Pull the hinge out of the control unit to remove the control unit cover.

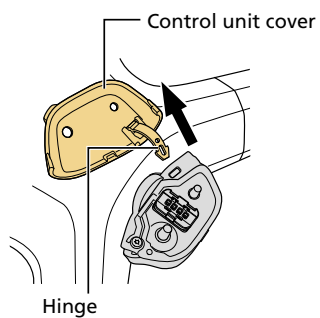

2. Install the new control unit cover.

Insert a tool such as a 1.5 mm hexagon wrench in the hole of the hinge, and insert it into the control unit cover installation hole.

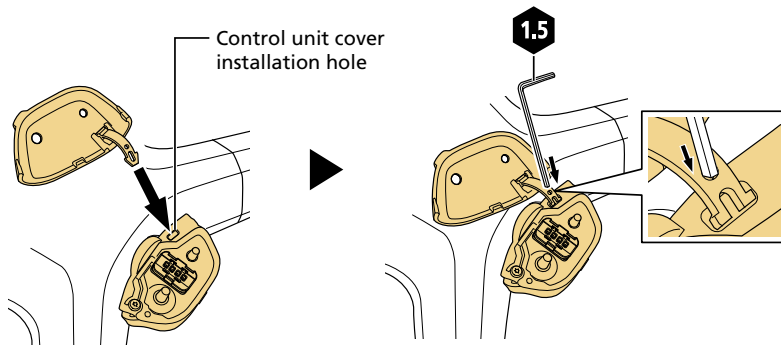

Troubleshooting

Introduction

Check the following information if you have a problem with the product.

If the problem is not covered below or cannot be solved with the indicated method, contact the place of purchase or a distributor.

If the power value has changed, you can perform calibration. For details, consult with a distributor.

Troubleshooting

Introduction

The power is not displayed	The cycle computer may not be connected wirelessly. Connect it wirelessly. (Refer to the section " Wireless functions ".)
	The battery may be exhausted. Check the battery level. If the battery level is low, charge the battery. (Refer to the section " Charging procedures ".)
	The connector of the left crank may be disconnected. Remove the outer cap, and check whether the connector is connected. (Refer to the section " Installing the crank ".)
The power value is abnormal	The zero offset may not be calibrated correctly. Calibrate the zero offset. (Refer to the section " Zero offset calibration ".)
The cadence is not displayed	The magnet may not be installed or the installation position may be inappropriate. If it is not installed or the installation position is inappropriate, install it correctly. (Refer to the section " Installing the magnet ".)
The cadence value is abnormal	Another cadence sensor may be installed. If it is installed, remove it or disable its settings.
Force vector is not displayed	The firmware version may not support force vector display. Use E-TUBE PROJECT Cyclist to update the firmware.
	Magnet calibration may not have been performed. Refer to the user's manual for E-TUBE PROJECT Cyclist to perform magnet calibration.
	Force vector may not be selected in the transmission settings of the communication method that the connected device is using. Refer to the user's manual for E-TUBE PROJECT Cyclist to check the transmission settings.
The LED flashes red when calibrating the zero offset	A problem may have occurred when calibrating the zero offset. Check the connector and calibrate the zero offset again. (Refer to the sections " Installing the crank " and " Zero offset calibration ".)
Cannot charge	The battery charger may be connected via a USB hub. Connect the battery charger directly to a PC or AC adapter and attempt to charge again.
	The charging cable may be broken. If charging cannot be performed via a different PC or an AC adapter with a USB port, replace the charging cable.
Cannot connect to the cycle computer	The cycle computer may not be supported. Check the manual for the cycle computer.
	The device may be receiving electromagnetic interference. Electromagnetic interference may prevent connections from being performed correctly in the following places or circumstances: * Near a device such as a television, computer, radio, or motor, or inside an automobile or railway car * Near a railway crossing or railway track, television transmitting station, or radar base, etc. * When using the device in combination with another cordless device or some lights Change the connection environment and connect again.

Hardware reset

Perform a hardware reset if troubleshooting does not solve the problem.

Check the operation again after the hardware reset is complete. If the problem is not solved, consult the place of purchase or a distributor.

- 1. Press and hold the button of the control unit for 15 seconds.**

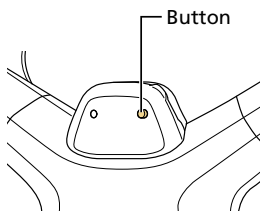

- 2. Let go of the button to complete the hardware reset.**

When the hardware reset is complete, the LED lights up and the battery level is displayed.

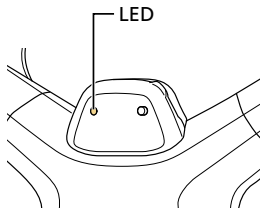

Connection and communication with devices

E-TUBE PROJECT Cyclist can be used to update the firmware, after connecting this product to a smartphone or tablet via Bluetooth® LE.

You need E-TUBE PROJECT Cyclist to configure the system and update firmware.

Download E-TUBE PROJECT Cyclist from our support website (<https://bike.shimano.com/e-tube/project.html>).

For information on how to install E-TUBE PROJECT Cyclist, check the support website.

NOTICE

- Firmware is subject to change without notice.
- E-TUBE PROJECT Cyclist cannot be used while the charging cable is connected.
- Do not perform the following operations while updating the firmware:
 - Press the button of the control unit
 - Disconnect or connect the charging cable
 - Move the crank

Specifications

Operating temperature range	-10°C - 50°C
Battery type	Li-Ion
Standard charging time	2.5 hours
Charging temperature	0°C - 45°C
Continuous operation time	Minimum: 70 hours / Maximum: 300 hours (temperature: 25°C)
Wireless specifications	ANT+ TM / Bluetooth [®] LE

